

# i-NEXT DW

3 – 150 kW

**FULL INVERTER** direct expansion air conditioners for IT Cooling  
Equipped with built-in water-cooled condenser



The picture of the unit is indicative and may vary depending on the model

- PERIMETER INSTALLATION
- FULLY HERMETIC BLDC INVERTER COMPRESSORS
- SINGLE OR DOUBLE REFRIGERANT CIRCUIT
- AIR DELIVERY FROM THE BOTTOM (UNDER) OR FROM THE TOP (OVER)
- PLUG FANS WITH EC ELECTRIC MOTOR
- ELECTRONIC EXPANSION VALVE
- AIR SUCTION TEMPERATURE UP TO 40°C

Technical Bulletin: T\_iNEXTDW\_0118\_GB

## INDEX

MEHITS CERTIFICATIONS .....	3
GENERAL CHARACTERISTICS .....	4
INSTALLATION .....	5
PRODUCT FEATURES AND BENEFITS .....	5
F-GAS DIRECTIVE .....	5
MODEL IDENTIFICATION .....	6
STORING TEMPERATURE .....	6
WORKING LIMITS .....	7
MAIN COMPONENTS .....	8
OPTIONAL ACCESSORIES .....	10
TECHNICAL DATA – i-NEXT DW OVER / UNDER – SINGLE REFRIGERANT CIRCUIT .....	11
TECHNICAL DATA – i-NEXT DW OVER / UNDER – DOUBLE REFRIGERANT CIRCUIT .....	14
REFRIGERANT CIRCUIT .....	17
ACOUSTIC DATA .....	19
ELECTRICAL DATA .....	20
MICROPROCESSOR CONTROL SYSTEM .....	21
POSSIBLE AIR INTAKE FOR OVER VERSIONS .....	23
OPTIONAL ACCESSORIES – DOUBLE POWER SUPPLY WITH AUTOMATIC TRANSFER SWITCH .....	24
OPTIONAL ACCESSORIES – NETWORK ANALYZER .....	25
OPTIONAL ACCESSORIES – FIRE / SMOKE SENSORS .....	26
OPTIONAL ACCESSORIES - CONDENSATE DISCHARGE PUMP .....	27
OPTIONAL ACCESSORIES – MODULATING STEAM HUMIDIFIER .....	28
OPTIONAL ACCESSORIES – DEHUMIDIFICATION SYSTEM .....	29
OPTIONAL ACCESSORIES - 2-WAY MOTORIZED VALVE FOR CONDENSING CONTROL .....	30
OPTIONAL ACCESSORIES – ELECTRIC HEATERS .....	31
OPTIONAL ACCESSORIES - HOT GAS RE-HEATING SYSTEM .....	32
OPTIONAL ACCESSORIES - FLOOR STAND .....	34
OPTIONAL ACCESSORIES - DOUBLE PANELS IN EUROCLASS A1 .....	35
OPTIONAL ACCESSORIES – M5 EFFICIENCY AIR FILTERS .....	35
OPTIONAL ACCESSORIES – NON-RETURN MOTORIZED DAMPER .....	36
OPTIONAL ACCESSORIES - PLENUM ON AIR DELIVERY/RETURN .....	38
OPTIONAL ACCESSORIES – DIRECT FREE-COOLING PLENUM .....	46
OPTIONAL ACCESSORIES – BOTTOM PANEL FOR OVER VERSION .....	49
OPTIONAL ACCESSORIES – KIPLINK – KEYBOARD IN YOUR POCKET .....	49
OPTIONAL ACCESSORIES – RC CLOUD PLATFORM: WEB SERVICES BASED ON CLOUD TECHNOLOGY FOR REMOTE MONITORING AND MANAGEMENT OF AIR CONDITIONING PLANTS .....	50
MACHINE DRAWINGS .....	51
HOLE IN THE RAISED FLOOR FOR DOWNFLOW VERSION .....	66
EXAMPLE FOR MACHINES NOISE EMISSION CALCULATION .....	67
VALVE PRESSURE DROP CALCULATION AS FUNCTION OF WATER FLOW RATE .....	69
AIR FILTERS REPLACEMENT .....	70

**MEHITS CERTIFICATIONS**

**SYSTEM CERTIFICATIONS**



**ISO 9001 CERTIFICATION – MEHITS S.p.A.**  
Quality Management System



**ISO 14001 CERTIFICATION – MEHITS S.p.A.**  
Environmental Management System



**BS OHSAS 18001 CERTIFICATION – MEHITS S.p.A.**  
Occupational Health and Safety Management System

**PRODUCT CERTIFICATIONS BY COUNTRY**



**CE MARKING**  
MEHITS units are in compliance with the European Directives in force.



**CCC – CQC CERTIFICATION**  
(People's Republic of China)



**EAC CERTIFICATION**  
(Russian Federation, Belarus, Kazakhstan)



## GENERAL CHARACTERISTICS



**i-NEXT DW U**  
Downflow air delivery



**i-NEXT DW O**  
Upflow air delivery

### i-NEXT DW: FULL INVERTER Air Conditioners for IT Cooling.

- Direct expansion, water cooled.
- Equipped with built-in water cooled condenser
- BLDC inverter compressors.
- Plug fans with EC electric motor.
- Single or double refrigerant circuit.

This series is offered in 10 models available in the following versions:

- The upflow version (Over) is characterized by air intake from the front through honeycomb grille and air delivery from the top of the unit.
- The downflow version (Under) is characterized by air intake from the top and air delivery from the bottom of the unit.

Cooling capacity: 3 ÷ 150 kW

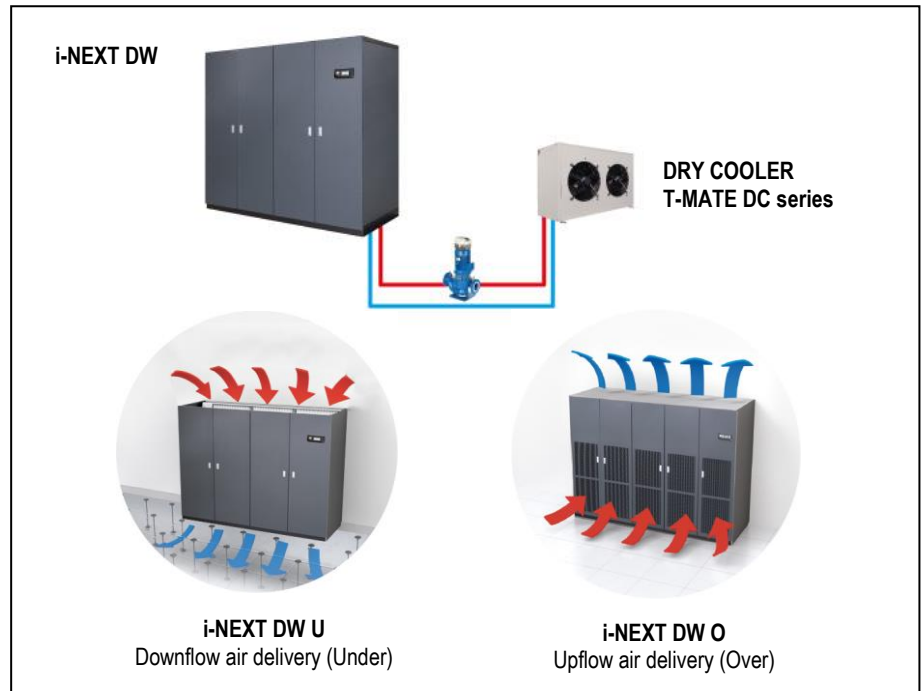

The machines are made for indoor installation.

The constructive solutions and the internal lay-out allow high application flexibility and the frontal access to the main components for the inspection and routine maintenance.

The installation requires electrical and hydraulic connections.

Final assembly on all machines before shipment including running test, reading and monitoring of operating parameters, alarms simulation and visual check.



## INSTALLATION

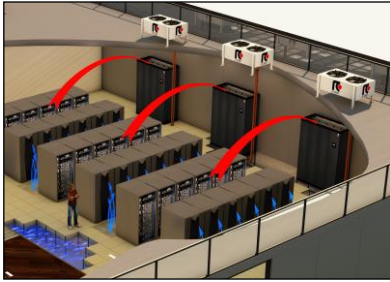

The series is particularly suitable for installation in Data Center of medium / small size with variable load.

### DOWNFLOW VERSION (Under)

Typical installation is on the perimeter.

The units are placed along the perimeter of the data center. Air suction from the top of the unit and air delivery in the underfloor void.

The air distribution is achieved by special tiles placed in front of the racks row, forming cold aisle for air diffusion. On the rear of the racks is expelled the hot then aspirated by the unit.

For an optimal installation is advisable to provide the cold aisle containment.



Some solutions provide a service corridor around the server rooms where to place the units. In this case it is necessary to provide the air intake plenum for each unit. With this solution all the space in the Data Center is available for the installation of racks.

### UPFLOW VERSION (Over)

The type of installation is practically similar to the previous. The only difference is that for the air distribution in the Data Center is not used the raised floor but ducts in the ceiling.

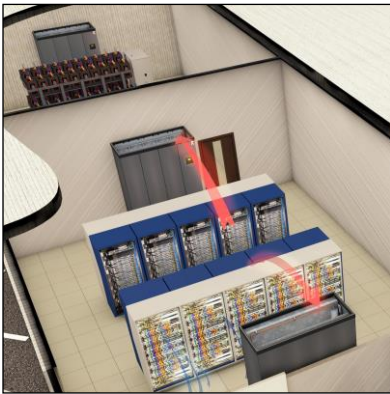

The series is also suitable for installation in UPS, Batteries, Distribution rooms and in all service areas of the data center that need a service of conditioning.

### OPTIONAL

An extensive list of accessories allows the unit to adapt effectively to the real needs of the system, reducing the time and cost of installation.

## PRODUCT FEATURES AND BENEFITS

### i-NEXT DW:

- EER up to 8,17 at partial load;
- Single BLDC scroll inverter compressor for each refrigerant circuit in order to provide always the best efficiency;
- New plug fans with EC electric motors and impeller in composite material, which guarantees a reduction of power consumption;
- New fans electric motor that do not require maintenance;
- Total modulating, capable to follow the increasing demand of Data Center;
- Improvement of the control software, developed by MEHITS, with advanced control logic;
- Single or double refrigerant circuit;
- Hinged frontal panels and lateral panels fully removable to facilitate the operations of extraordinary maintenance;

## F-GAS DIRECTIVE

The units highlighted in this publication contain <HFC R410A [GWP<sub>100</sub> 2088]> fluorinated greenhouse gases.

## MODEL IDENTIFICATION

### Air conditioners for IT Cooling

model: i-NEXT DW O 047 M1 S E5L

<b>i-NEXT</b>	<b>Series</b>
<b>DW</b>	<b>Unit type</b> DW – direct expansion, water cooled
<b>O</b>	<b>Air delivery</b> O = over – upflow air delivery U = under – downflow air delivery
<b>047</b>	<b>Model / Cooling capacity (kW) at nominal conditions</b>
<b>M1</b>	<b>Compressor type and number</b> M = BLDC inverter compressor for R410A 1 = 1 BLDC inverter compressor 2 = 1 BLDC inverter compressor for refrigerant circuit 4 = 1 BLDC inverter + 1 ON/OFF compressor for refrigerant circuit
<b>S</b>	<b>Refrigerant circuit</b> S = single D = double
<b>E5L</b>	<b>Size</b>

## STORING TEMPERATURE

If the machine is not installed on receipt and is stored for a long time, store it in a protected place, at temperatures ranging between -30°C and 50°C in absence of superficial condensation and direct sun light.

**WORKING LIMITS**

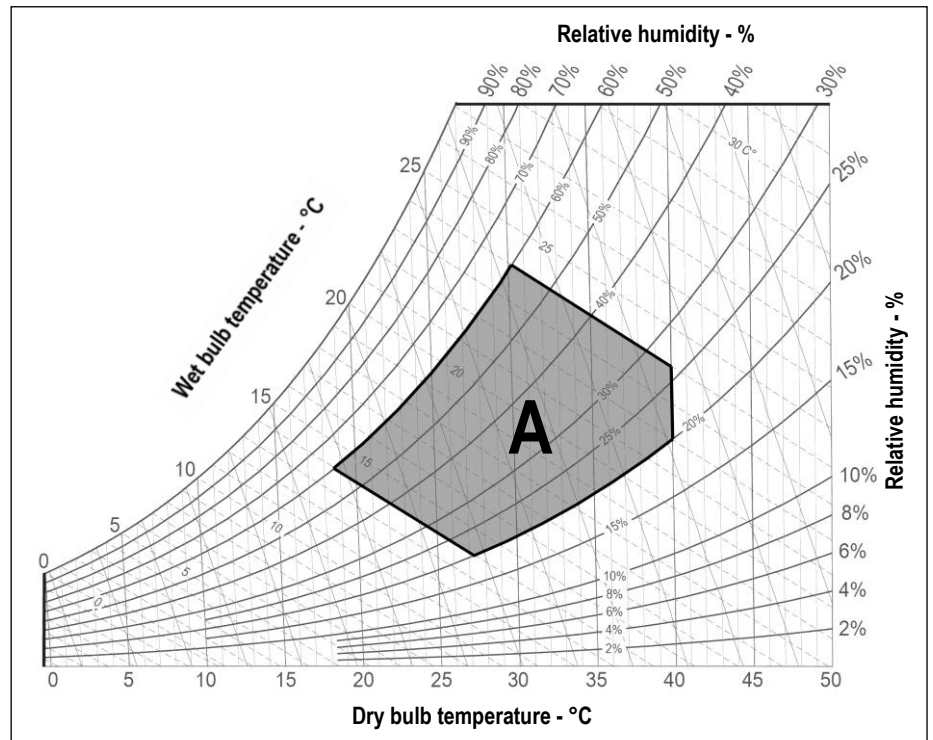

**ROOM AIR CONDITIONS**

Room air temperature:

- 14°C            minimum temperature with wet bulb.
- 24°C            maximum temperature with wet bulb.
- 18°C            minimum temperature with dry bulb.
- 40°C            maximum temperature with dry bulb.

**AREA "A". Machine operating envelope.**

Room air humidity:

- 20%RH        minimum relative humidity.
- 60%RH        maximum relative humidity.

**WATER COOLED CONDENSER**

Water temperature:

- 30/50°C        Outlet temperature range.

All the values are indicative. The working temperatures are influenced by a series of variables as:

- Working conditions;
- Thermal load;
- Set of the microprocessor control.

**POWER SUPPLY**

- ± 10%            Maximum tolerance of the supply voltage (V)

## MAIN COMPONENTS



### FRAMEWORK

- Base in aluminium extrusion, painted with epoxy powders. Colour RAL 9005;
- Frame in aluminium profile, painted with epoxy powders. The inner frame is provided with seals for the panels. Colour RAL 9005;
- Panels in galvanized steel sheet with protective surfaces treatment in compliance with UNI ISO 9227/ASTMB117 and ISO 7253, and painted with epoxy powders. Colour RAL 7016 hammered;
- Panels insulated with polyurethane foam and seals to ensure air tight.
- Hinged front panels with quick release removal system.
- Total front access for routine maintenance.
- Removable lateral and back side panels.
- Air flow OVER version:
  - Air intake from the front through honeycomb type grille and air delivery from the top.
- Air flow UNDER version:
  - Air intake from the top and air delivery from the bottom.
- Compartment for electrical panel on unit front for direct access to control and regulation devices;

### FILTER SECTION

- Washable air filters with G4 efficiency, with cells in synthetic fibre and metallic frame (EN 779-2012).
- Air filters access:
  - OVER version
    - Frontal access for all machines
  - UNDER version
    - For machines size E1 - E2 – E3 frontal access
    - For machine size E4L – E5L – E7L – E8L – E9L access from upper side
- Differential pressure switch on the air side for clogged filters alarm signal.

### BLDC INVERTER COMPRESSORS SECTION

Unit size E1:

- rotary BLDC inverter compressor for R410A refrigerant:

Unit size E2, E3, E4L, E5L, E7L, E8L:

- scroll BLDC inverter compressors with spiral profile optimized for R410A refrigerant:
  - S version, single refrigerant circuit:
    - single BLDC inverter compressor;
  - D version, double refrigerant circuit:
    - single BLDC inverter compressor for each refrigerant circuit;
- Synchronous brushless inverter driven motor.
- Inverter for modulating capacity control.
- Reactance for the reduction of electromagnetic noise and interference.

#### ONLY FOR UNIT SIZE E9L – DOUBLE REFRIGERANT CIRCUIT

- One BLDC inverter compressor + one on/off compressor for each refrigerant circuit.
- Characteristics of on/off compressor:
  - Scroll rotary compressors with spiral profile optimized for R410A refrigerant.
  - 2-pole 3-phase electric motor with direct on line starting.

#### FOR ALL COMPRESSORS:

- Crankcase heater for each compressor.
- Soundproof cap for each compressor.
- Rubber supports.

### FAN SECTION

The fan section is contained within the machine and includes:

- Centrifugal fans with backward curved blades with wing profile, single suction and without scroll housings (Plug-fans), directly coupled to external rotor electric motor.
- Impeller in composite material exempt from rust formation.
- Brushless type synchronous EC motor with integrated electronic commutated system and continuous variation of the rotation speed.
- The motor rotation control is obtained with the EC system (Electronic Commutation) that manage the motor according to the signal coming from the microprocessor control.
- Fans control with proportional signal 0-10V.
- Fan guard with rubber support (UNDER version)





## COOLING SECTION

- Heat exchanger coil with internally corrugated copper tubes and high efficiency aluminium fins, specifically developed to provide high heat transfer and lower pressure drops.
- Frame in galvanized steel or peralluman.
- Condensate tray in peralluman with PVC flexible discharge pipe.
- Temperature sensors on air intake with control and regulation functions.
- Temperature sensors on air delivery with function of control and regulation.
- Under floor water alarm through sensor to be placed on the floor.

## CONDENSING SECTION

- Copper brazed plate type with cover plates, plates and connections in AISI 316 stainless steel.
- 0÷10V proportional signal to manage the condensing control system

## REFRIGERANT CIRCUIT

Components for each refrigerant circuit:

- Electronic expansion valve. The valve allows high performance and system efficiency thanks to a timely and accurate response to changes in temperature and pressure
- Sight glass.
- Filter dryer on liquid line.
- Pressure transducers with indication, control and protection functions, on low and high refrigerant pressure.
- High pressure safety switch with manual reset.
- Liquid receiver with accessories.
- Refrigerant circuit with copper tubing with anticondensate insulation of the suction line.
- R410A refrigerant charge and lubricant oil.

## ELECTRICAL PANEL

In accordance with EN60204-1 norms, suitable for indoor installation, complete with:

- Main switch with door lock safety on frontal panel.
  - Magnetothermic switches for each compressor.
  - Magnetothermic switches for supply fans.
  - Contactors for each load. BLDC inverter compressors and supply fans equipped with EC electric motor don't require contactors.
  - Unit size E9L, D version, double refrigerant circuit:
    - Phases sequence control relay for the machine. The system checks that the phase sequence of the power supply is correct to prevent the opposite rotation of the three phase electric motors of the machine as compressor motors, fan motors. It is installed downstream the main switch with door lock safety and in case of wrong phase sequence prevents starting the machine;
  - Transformer for auxiliary circuit and microprocessor supply.
  - Terminals:
- OUTLETS**
- Voltage free deviating contact for General Alarm 1,2.
  - Voltage free contact for supply fans status.
- INLETS**
- External enabling.
- Power supply 400/3/50+N.

## CONTROL SYSTEM

Microprocessor control system with graphic display for control and monitor of operating and alarms status. The system includes:

- Built-in clock for alarms date and time displaying and storing;
- Built-in memory for the storing of the intervened events (up to 200 events recorded);
- Predisposition for connectivity board housing (MBUS RS485/JBUS, MBUS RS232/JBUS for GSM modem, LON, BACnet for Ethernet (SNMP- TCP/IP), BACnet for MS/TP). The electronic cards are optional accessories;
- Main components hour-meter;
- Non-volatile "Flash" memory for data storage in case of power supply faulty;
- Menu with protection password;
- Demand Limit function (for machines with double refrigerant circuit only);
- LAN connection (max 10 units).

## OPTIONAL ACCESSORIES

The descriptions of these additional components can be found in Chapter OPTIONAL ACCESSORIES.

- Double power supply with automatic change-over. Not compatible with “oversized electric heaters” and “oversized humidifier” optional accessories.
- Network analyser: multifunction utility for calculating and displaying the machine electrical measurements. Not compatible with “oversized electric heaters” and “oversized humidifier” optional accessories.
- Smoke sensor. Supplied in mounting kit.
- Fire sensor. Supplied in mounting kit.
- Condensate drain system including pump with activation float and 10 linear meters long discharge pipe. For all the machines the optional is supplied in mounting kit.
- Modulating steam humidifier with immersed electrodes with electronic control. The optional foresee the combined Temperature / Humidity sensor on return air.
- Dehumidification system. The optional foresee the combined Temperature / Humidity sensor on return air.
- 2-way motorized valve for condensing control with 0÷10 VDC control actuator and emergency manual control.
- Electric heating system consisting of aluminium armoured elements with integral fins.
- On/off type hot gas reheating system. For machine with double refrigerant circuit, the system is applied to a single refrigerant circuit. Not compatible with “hot water heating system” and with “electric heating system”.
- Unit floor stand with height adjusting rubber holders. It is not possible to match the unit floor stand with plenum installed under the machine.
- Double panels Euroclass A1.
- Washable air filter with M5 efficiency. Not compatible with optional plenum with M6/F7/F9 efficiency filters on air delivery.
- Non-return air damper driven by electric servomotor installed on the machine air delivery.
- Empty plenum. Available in Euroclass A1.
- Plenum with noise absorption partitions on air delivery. Not compatible with optional washable air filter with M5 efficiency.
- Plenum with noise absorption partitions on air return. Not compatible with optional washable air filter with M5 efficiency.
- Plenum with M6/F7/F9 efficiency filters on air delivery. Not compatible with optional washable air filter with M5 efficiency.
- Air distribution plenum with double row adjustable grille on front side. Available in Euroclass A1.
- Air distribution plenum with double row adjustable grilles on three sides. Available in Euroclass A1.
- Air distribution plenum with double row adjustable grille on front side and noise absorption partitions.
- Plenum for direct free-cooling on air intake. The optional foresee the combined Temperature / Humidity sensor on machine air suction and the Temperature sensor for ambient air.
- Unit base noise insulation with special bottom panel for OVER version.  
Restriction: Not compatible with blind frontal panel for OVER version.
- KIP LINK: Keyboard in your pocket. Allows to operate on the unit with smartphone or tablet.
- RC CLOUD PLATFORM: Web services based on cloud technology for remote monitoring and management.

## OTHER ACCESSORIES

- Automatic system for the air pressure control in the under floor. The system controls the supply fans rotation speed in order to keep constant the air pressure in the under floor via a differential pressure transmitter connected to the microprocessor control.
- Solenoid valve on liquid line.
- Blind frontal panel for OVER version. The accessory allows the intake air from the bottom of the machine.  
Restriction: Not compatible with unit base noise insulation with special bottom panel for OVER version.
- Additional underfloor water sensor kit.
- Phases sequence control relay for the machine. The system checks that the phase sequence of the power supply is correct to prevent the opposite rotation of the three phase electric motors of the machine as compressor motors, fan motors. The optional is installed in the electrical box downstream the main switch with door lock safety and in case of wrong phase sequence prevents starting the machine (standard for size E9);
- Combined Temperature / Humidity sensor on return air.
- Temperature sensor for outdoor installation.
- Combined Temperature / Humidity sensor for remote installation. The optional is added to the standard sensor on machine air suction.
- Microprocessor control accessories:
  - Remote terminal.
  - Serial card MBUS RS485/JBUS.
  - Serial card MBUS RS232/JBUS for GSM modem.
  - Serial card LON.
  - Serial card BACnet for Ethernet – SNMP – TCP/IP.
  - Serial card BACnet for MS/TP.
  - Temporary microprocessor power supply. The system guarantees the microprocessor power supply for a few minutes, in case of supply voltage failure.
  - Free contact for on/off compressor operating status monitoring (only for size E9) .
  - Smoke / Fire sensor contact.
  - Analogue set point compensation according to an external analogue signal at Customer care.  
The microprocessor control, through the additional module “expansion card”, can manage a compensation signal of the return air setpoint by analogue input (0...1V; 0...5V; 0,5...4,5V; 4...20mA; 0...20mA). The compensation curve allows to assign a temperature setpoint offset respectively to the minimum and maximum signal managed by the input.

## WARNING

**MEHITS reserves the right to accept the matching of the optional installed on the machine.**

## TECHNICAL DATA – i-NEXT DW Over / Under – Single Refrigerant Circuit

MODEL	012 M1 S			018 M1 S			
SIZE	E1			E2			
COOLING CAPACITY (1)	Min	Nom	Max	Min	Nom	Max	
Total	kW	3,4	9,7	11,0	7,5	19,2	21,7
Sensible	kW	3,4	9,7	11,0	7,5	17,8	20,0
SHR (2)	kW/kW	1,00	1,00	1,00	1,00	0,93	0,92
Total power input (Comp. + Fans)	kW	-	1,77	-	-	4,24	-
Condenser water flow rate	m <sup>3</sup> /h	-	1,9	-	-	4,0	-
Condenser pressure drop	kPa	-	21	-	-	31	-
<b>"EC" SUPPLY FANS</b>	n.	-	1	-	-	1	-
Air flow	m <sup>3</sup> /h	-	2700	-	-	4100	-
Nominal external static pressure	Pa	-	20	-	-	20	-
Maximum external static pressure	Pa	-	85	-	-	315	-
Power input (3)	kW	-	0,26	-	-	0,52	-
<b>COMPRESSORS</b>	BLDC Rotary Inverter			BLDC Scroll Inverter			
BLDC INVERTER compressors	n.	1			1		
On/Off compressors	n.	0			0		
Cooling Capacity Control	Modulante			Modulante			
Compressors power input	kW	1,51			3,73		
<b>WATER COOLED CONDENSER</b>	1			1			
Water volume	l	1,1			1,1		
Max water flow rate	m <sup>3</sup> /h	5,7			6,4		
<b>AIR FILTERS</b>	n.			1			
Filtering surface	m <sup>2</sup>	0,6			0,8		
Efficiency	G4			G4			
<b>REFRIGERANT</b>	R410A			R410A			
Refrigerant circuit x Refrigerant charge (4)	n x kg	1 x 3,2			1 x 3,8		
HFC R410A - F Gas - CO <sub>2</sub> equivalent	t	6,7			7,9		
<b>POWER SUPPLY</b>	V/Ph/Hz	400/3/50+N			400/3/50+N		
<b>ENERGY EFFICIENCY INDEXES (1)</b>							
EER - Energy Efficiency Ratio	kW/kW	-	5,50	-	-	4,53	-
<b>DIMENSIONS</b>							
Length	mm	650			785		
Width	mm	675			675		
Height	mm	1925			1925		
<b>NET WEIGHT Over</b>	kg	230			280		
<b>NET WEIGHT Under</b>	kg	240			290		
<b>CONNECTIONS ISO 228/1-G</b>							
Condenser water inlet/outlet	M Ø	1"			1"		
<b>HYDRAULIC CONNECTIONS</b>							
<b>CONDENSATE DISCHARGE</b>							
Rubber pipe – internal diameter	Ø mm	19			19		

### THE COOLING CAPACITY DOES NOT CONSIDER THE SUPPLY FAN MOTOR THERMAL LOAD

1. Gross value. Characteristics referred to entering air at 26°C-40%UR; water to the condenser 30-35°C; ESP=20Pa.
2. SHR = Sensible cooling capacity / Total cooling capacity.
3. Corresponding to the nominal external static pressure.
4. **The air conditioner is supplied charged with R410A refrigerant charge.** Unit refrigerant charge, optional excluded. For air conditioners with double refrigerant circuit is indicated the number of circuits x the charge of a single circuit.

The units highlighted in this publication contain <HFC R410A [GWP<sub>100</sub> 2088]> fluorinated greenhouse gas.

## TECHNICAL DATA – i-NEXT DW Over / Under – Single Refrigerant Circuit

MODEL	022 M1 S			030 M1 S			
SIZE	E3			E4L			
COOLING CAPACITY (1)	Min	Nom	Max	Min	Nom	Max	
Total	kW	8,4	23,9	25,3	16,1	32,6	41,2
Sensible	kW	8,4	22,3	23,3	16,1	31,2	39,1
SHR (2)	kW/kW	1,00	0,93	0,92	1,00	0,96	0,95
Total power input (Comp. + Fans)	kW	-	5,32	-	-	6,77	-
Condenser water flow rate	m <sup>3</sup> /h	-	5,0	-	-	6,7	-
Condenser pressure drop	kPa	-	29	-	-	17	-
<b>"EC" SUPPLY FANS</b>	n.	-	1	-	-	1	-
Air flow	m <sup>3</sup> /h	-	5100	-	-	7500	-
Nominal external static pressure	Pa	-	20	-	-	20	-
Maximum external static pressure	Pa	-	670	-	-	605	-
Power input (3)	kW	-	0,6	-	-	0,9	-
<b>COMPRESSORS</b>	BLDC Scroll Inverter			BLDC Scroll Inverter			
BLDC INVERTER compressors	n.	1			1		
On/Off compressors	n.	0			0		
Cooling Capacity Control	Modulante			Modulante			
Compressors power input	kW	4,72			5,87		
<b>WATER COOLED CONDENSER</b>	1			1			
Water volume	l	1,9			3,7		
Max water flow rate	m <sup>3</sup> /h	6,9			11,2		
<b>AIR FILTERS</b>	n.	2			2		
Filtering surface	m <sup>2</sup>	1,2			2,1		
Efficiency	G4			G4			
<b>REFRIGERANT</b>	R410A			R410A			
Refrigerant circuit x Refrigerant charge (4)	n x kg	1 x 4,6			1 x 6,8		
HFC R410A - F Gas - CO <sub>2</sub> equivalent	t	9,6			14,2		
<b>POWER SUPPLY</b>	V/Ph/Hz	400/3/50+N			400/3/50+N		
<b>ENERGY EFFICIENCY INDEXES (1)</b>							
EER - Energy Efficiency Ratio	kW/kW	-	4,49	-	-	4,82	-
<b>DIMENSIONS</b>							
Length	mm	1085			1630		
Width	mm	775			930		
Height	mm	1925			1980		
<b>NET WEIGHT Over</b>	kg	325			480		
<b>NET WEIGHT Under</b>	kg	345			490		
<b>CONNECTIONS ISO 228/1-G</b>							
Condenser water inlet/outlet	M Ø	1 1/4"			1 1/2"		
<b>HYDRAULIC CONNECTIONS</b>							
<b>CONDENSATE DISCHARGE</b>							
Rubber pipe – internal diameter	Ø mm	19			19		

### THE COOLING CAPACITY DOES NOT CONSIDER THE SUPPLY FAN MOTOR THERMAL LOAD

1. Gross value. Characteristics referred to entering air at 26°C-40%UR; water to the condenser 30-35°C; ESP=20Pa.
2. SHR = Sensible cooling capacity / Total cooling capacity.
3. Corresponding to the nominal external static pressure.
4. **The air conditioner is supplied charged with R410A refrigerant charge.** Unit refrigerant charge, optional excluded. For air conditioners with double refrigerant circuit is indicated the number of circuits x the charge of a single circuit.

The units highlighted in this publication contain <HFC R410A [GWP<sub>100</sub> 2088]> fluorinated greenhouse gas.

## TECHNICAL DATA – i-NEXT DW Over / Under – Single Refrigerant Circuit

MODEL		047 M1 S		
SIZE		E5L		
COOLING CAPACITY (1)		Min	Nom	Max
Total	kW	18,4	50,9	56,1
Sensible	kW	18,4	48,0	51,6
SHR (2)	kW/kW	1,00	0,94	0,92
Total power input (Comp. + Fans)	kW	-	11,70	-
Condenser water flow rate	m <sup>3</sup> /h	-	10,4	-
Condenser pressure drop	kPa	-	41	-
<b>"EC" SUPPLY FANS</b>		-	1	-
Air flow	m <sup>3</sup> /h	-	12000	-
Nominal external static pressure	Pa	-	20	-
Maximum external static pressure	Pa	-	115	-
Power input (3)	kW	-	2,27	-
<b>COMPRESSORS</b>		BLDC Scroll Inverter		
BLDC INVERTER compressors	n.	1		
On/Off compressors	n.	0		
Cooling Capacity Control		Modulante		
Compressors power input	kW	9,41		
<b>WATER COOLED CONDENSER</b>		1		
Water volume	l	3,7		
Max water flow rate	m <sup>3</sup> /h	15,4		
<b>AIR FILTERS</b>		n.		
Filtering surface	m <sup>2</sup>	2,6		
Efficiency		G4		
<b>REFRIGERANT</b>		R410A		
Refrigerant circuit x Refrigerant charge (4)	n x kg	1 x 9,9		
HFC R410A - F Gas - CO <sub>2</sub> equivalent	t	20,7		
<b>POWER SUPPLY</b>	V/Ph/Hz	400/3/50+N		
<b>ENERGY EFFICIENCY INDEXES (1)</b>				
EER - Energy Efficiency Ratio	kW/kW	-	4,35	-
<b>DIMENSIONS</b>				
Length	mm	1955		
Width	mm	930		
Height	mm	1980		
<b>NET WEIGHT Over</b>	kg	580		
<b>NET WEIGHT Under</b>	kg	590		
<b>CONNECTIONS ISO 228/1-G</b>				
Condenser water inlet/outlet	M Ø	2"		
<b>HYDRAULIC CONNECTIONS</b>				
<b>CONDENSATE DISCHARGE</b>				
Rubber pipe – internal diameter	Ø mm	19		

### THE COOLING CAPACITY DOES NOT CONSIDER THE SUPPLY FAN MOTOR THERMAL LOAD

1. Gross value. Characteristics referred to entering air at 26°C-40%UR; water to the condenser 30-35°C; ESP=20Pa.
2. SHR = Sensible cooling capacity / Total cooling capacity.
3. Corresponding to the nominal external static pressure.
4. **The air conditioner is supplied charged with R410A refrigerant charge.** Unit refrigerant charge, optional excluded. For air conditioners with double refrigerant circuit is indicated the number of circuits x the charge of a single circuit.

The units highlighted in this publication contain <HFC R410A [GWP<sub>100</sub> 2088]> fluorinated greenhouse gas.

## TECHNICAL DATA – i-NEXT DW Over / Under – Double Refrigerant Circuit

MODEL	042 M2 D				068 M2 D		
SIZE	E5L				E7L		
COOLING CAPACITY (1)		Min	Nom	Max	Min	Nom	Max
Total	kW	16,3	46,2	51,5	25,7	72,3	82,4
Sensible	kW	16,3	45,1	49,4	25,7	69,8	78,3
SHR (2)	kW/kW	1,00	0,98	0,96	1,00	0,97	0,95
Total power input (Comp. + Fans)	kW	-	10,60	-	-	15,70	-
Condenser water flow rate	m <sup>3</sup> /h	-	9,5	-	-	14,8	-
Condenser pressure drop	kPa	-	18	-	-	22	-
<b>"EC" SUPPLY FANS</b>	n.	-	1	-	-	2	-
Air flow	m <sup>3</sup> /h	-	12000	-	-	17500	-
Nominal external static pressure	Pa	-	20	-	-	20	-
Maximum external static pressure	Pa	-	115	-	-	535	-
Power input (3)	kW	-	2,27	-	-	2,34	-
<b>COMPRESSORS</b>		BLDC Scroll Inverter				BLDC Scroll Inverter	
BLDC INVERTER compressors	n.	2				2	
On/Off compressors	n.	0				0	
Cooling Capacity Control		Modulante				Modulante	
Compressors power input	kW	8,37				13,40	
<b>WATER COOLED CONDENSER</b>		1				1	
Water volume	l	3,4				5,6	
Max water flow rate	m <sup>3</sup> /h	14,0				22,4	
<b>AIR FILTERS</b>	n.	3				4	
Filtering surface	m <sup>2</sup>	2,59				3,83	
Efficiency		G4				G4	
<b>REFRIGERANT</b>		R410A				R410A	
Refrigerant circuit x Refrigerant charge (4)	n x kg	2 x 4,7				2 x 6,9	
HFC R410A - F Gas - CO <sub>2</sub> equivalent	t	19,6				28,8	
<b>POWER SUPPLY</b>	V/Ph/Hz	400/3/50+N				400/3/50+N	
<b>ENERGY EFFICIENCY INDEXES (1)</b>							
EER - Energy Efficiency Ratio	kW/kW	-	4,36	-	-	4,61	-
<b>DIMENSIONS</b>							
Length	mm	1955				2499	
Width	mm	930				930	
Height	mm	1980				1980	
<b>NET WEIGHT Over</b>	kg	610				730	
<b>NET WEIGHT Under</b>	kg	620				785	
<b>CONNECTIONS ISO 228/1-G</b>							
Condenser water inlet/outlet	M Ø	2"				2 1/2"	
<b>HYDRAULIC CONNECTIONS</b>							
<b>CONDENSATE DISCHARGE</b>							
Rubber pipe – internal diameter	Ø mm	19				19	

### THE COOLING CAPACITY DOES NOT CONSIDER THE SUPPLY FAN MOTOR THERMAL LOAD

1. Gross value. Characteristics referred to entering air at 26°C-40%UR; water to the condenser 30-35°C; ESP=20Pa.
2. SHR = Sensible cooling capacity / Total cooling capacity.
3. Corresponding to the nominal external static pressure.
4. **The air conditioner is supplied charged with R410A refrigerant charge.** Unit refrigerant charge, optional excluded. For air conditioners with double refrigerant circuit is indicated the number of circuits x the charge of a single circuit.

The units highlighted in this publication contain <HFC R410A [GWP<sub>100</sub> 2088]> fluorinated greenhouse gas.

## TECHNICAL DATA – i-NEXT DW Over / Under – Double Refrigerant Circuit

MODEL	094 M2 D			120 M4 D (*)			
SIZE	E8L			E9L			
COOLING CAPACITY (1)	Min	Nom	Max	Min	Nom	Max	
Total	kW	35,2	99,5	109,0	33,9	117,0	125,0
Sensible	kW	35,2	92,6	100,3	33,9	114,0	118,8
SHR (2)	kW/kW	1,00	0,93	0,92	1,00	0,97	0,95
Total power input (Comp. + Fans)	kW	-	22,30	-	-	27,20	-
Condenser water flow rate	m <sup>3</sup> /h	-	20,4	-	-	23,9	-
Condenser pressure drop	kPa	-	26	-	-	30	-
<b>"EC" SUPPLY FANS</b>	n.	-	2	-	-	3	-
Air flow	m <sup>3</sup> /h	-	22000	-	-	32000	-
Nominal external static pressure	Pa	-	20	-	-	20	-
Maximum external static pressure	Pa	-	280	-	-	270	-
Power input (3)	kW	-	3,72	-	-	5,99	-
<b>COMPRESSORS</b>		BLDC Scroll Inverter			BLDC Scroll Inverter + On/Off		
BLDC INVERTER compressors	n.	2			2		
On/Off compressors	n.	0			2		
Cooling Capacity Control		Modulante			Modulante		
Compressors power input	kW	18,60			21,20		
<b>WATER COOLED CONDENSER</b>		1			1		
Water volume	l	7,4			12,0		
Max water flow rate	m <sup>3</sup> /h	30,0			42,0		
<b>AIR FILTERS</b>	n.	5			6		
Filtering surface	m <sup>2</sup>	4,47			5,24		
Efficiency		G4			G4		
<b>REFRIGERANT</b>		R410A			R410A		
Refrigerant circuit x Refrigerant charge (4)	n x kg	2 x 10,1			2 x 10,8		
HFC R410A - F Gas - CO <sub>2</sub> equivalent	t	41,2			45,1		
<b>POWER SUPPLY</b>	V/Ph/Hz	400/3/50+N			400/3/50+N		
<b>ENERGY EFFICIENCY INDEXES (1)</b>							
EER - Energy Efficiency Ratio	kW/kW	-	4,46	-	-	4,30	-
<b>DIMENSIONS</b>							
Length	mm	2899			3299		
Width	mm	930			930		
Height	mm	1980			1980		
<b>NET WEIGHT Over</b>	kg	900			--		
<b>NET WEIGHT Under</b>	kg	960			1100		
<b>CONNECTIONS ISO 228/1-G</b>							
Condenser water inlet/outlet	M Ø	2 1/2"			3"		
<b>HYDRAULIC CONNECTIONS</b>							
<b>CONDENSATE DISCHARGE</b>							
Rubber pipe – internal diameter	Ø mm	19			19		

### THE COOLING CAPACITY DOES NOT CONSIDER THE SUPPLY FAN MOTOR THERMAL LOAD

1. Gross value. Characteristics referred to entering air at 26°C-40%UR; water to the condenser 30-35°C; ESP=20Pa.
  2. SHR = Sensible cooling capacity / Total cooling capacity.
  3. Corresponding to the nominal external static pressure.
  4. **The air conditioner is supplied charged with R410A refrigerant charge.** Unit refrigerant charge, optional excluded. For air conditioners with double refrigerant circuit is indicated the number of circuits x the charge of a single circuit.
- (\*) Only UNDER version.

The units highlighted in this publication contain <HFC R410A [GWP<sub>100</sub> 2088]> fluorinated greenhouse gas.

## TECHNICAL DATA – i-NEXT DW Under – Double Refrigerant Circuit

MODEL		150 M4 D (*)		
SIZE		E9L		
COOLING CAPACITY (1)		Min	Nom	Max
Total	kW	38,5	141,0	150,0
Sensible	kW	38,5	133,0	138,0
SHR (2)	kW/kW	1,00	0,94	0,92
Total power input (Comp. + Fans)	kW	-	32,80	-
Condenser water flow rate	m <sup>3</sup> /h	-	29,1	-
Condenser pressure drop	kPa	-	43	-
<b>"EC" SUPPLY FANS</b>		-	3	-
Air flow	m <sup>3</sup> /h	-	32000	-
Nominal external static pressure	Pa	-	20	-
Maximum external static pressure	Pa	-	270	-
Power input (3)	kW	-	5,99	-
<b>COMPRESSORS</b>		BLDC Scroll Inverter + On/Off		
BLDC INVERTER compressors	n.	2		
On/Off compressors	n.	2		
Cooling Capacity Control		Modulante		
Compressors power input	kW	26,80		
<b>WATER COOLED CONDENSER</b>		1		
Water volume	l	12,0		
Max water flow rate	m <sup>3</sup> /h	42,0		
<b>AIR FILTERS</b>		n.		
Filtering surface	m <sup>2</sup>	5,24		
Efficiency		G4		
<b>REFRIGERANT</b>		R410A		
Refrigerant circuit x Refrigerant charge (4)	n x kg	2 x 10,8		
HFC R410A - F Gas - CO <sub>2</sub> equivalent	t	45,1		
<b>POWER SUPPLY</b>		V/Ph/Hz		
<b>ENERGY EFFICIENCY INDEXES (1)</b>		400/3/50+N		
EER - Energy Efficiency Ratio	kW/kW	-	4,30	-
<b>DIMENSIONS</b>				
Length	mm	3299		
Width	mm	930		
Height	mm	1980		
<b>NET WEIGHT Over</b>	kg	--		
<b>NET WEIGHT Under</b>	kg	1125		
<b>CONNECTIONS ISO 228/1-G</b>				
Condenser water inlet/outlet	M Ø	3"		
<b>HYDRAULIC CONNECTIONS</b>				
<b>CONDENSATE DISCHARGE</b>				
Rubber pipe – internal diameter	Ø mm	19		

### THE COOLING CAPACITY DOES NOT CONSIDER THE SUPPLY FAN MOTOR THERMAL LOAD

1. Gross value. Characteristics referred to entering air at 26°C-40%UR; water to the condenser 30-35°C; ESP=20Pa.
  2. SHR = Sensible cooling capacity / Total cooling capacity.
  3. Corresponding to the nominal external static pressure.
  4. **The air conditioner is supplied charged with R410A refrigerant charge.** Unit refrigerant charge, optional excluded. For air conditioners with double refrigerant circuit is indicated the number of circuits x the charge of a single circuit.
- (\*) Only UNDER version.

The units highlighted in this publication contain <HFC R410A [GWP<sub>100</sub> 2088]> fluorinated greenhouse gas.



**REFRIGERANT CIRCUIT**

Below refrigerant diagrams for version with single or double refrigerant circuit. The diagrams refer to the standard configuration, without optional.

**UNDER - SINGLE REFRIGERANT CIRCUIT**

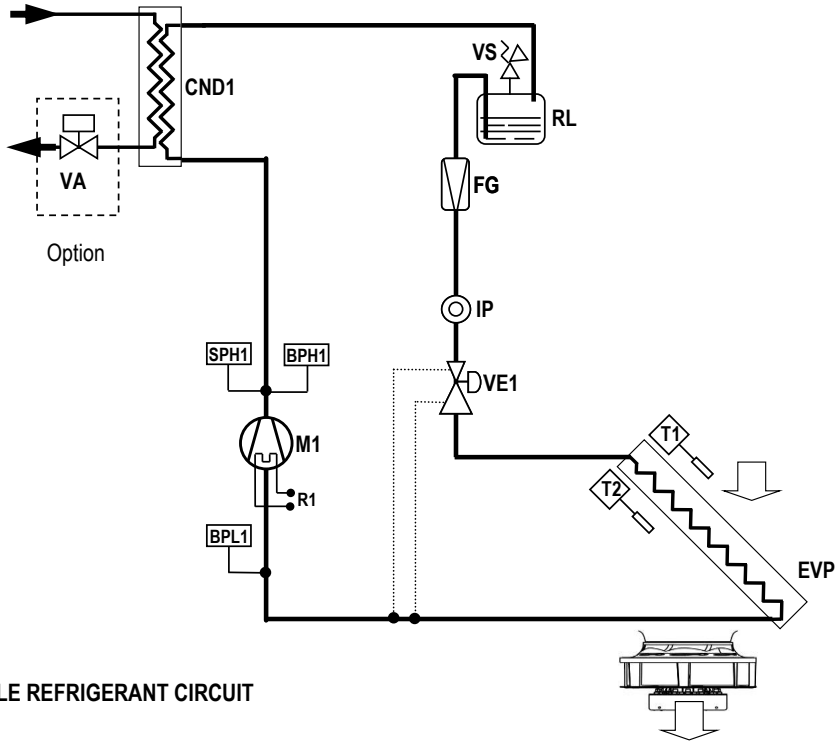

**OVER - SINGLE REFRIGERANT CIRCUIT**

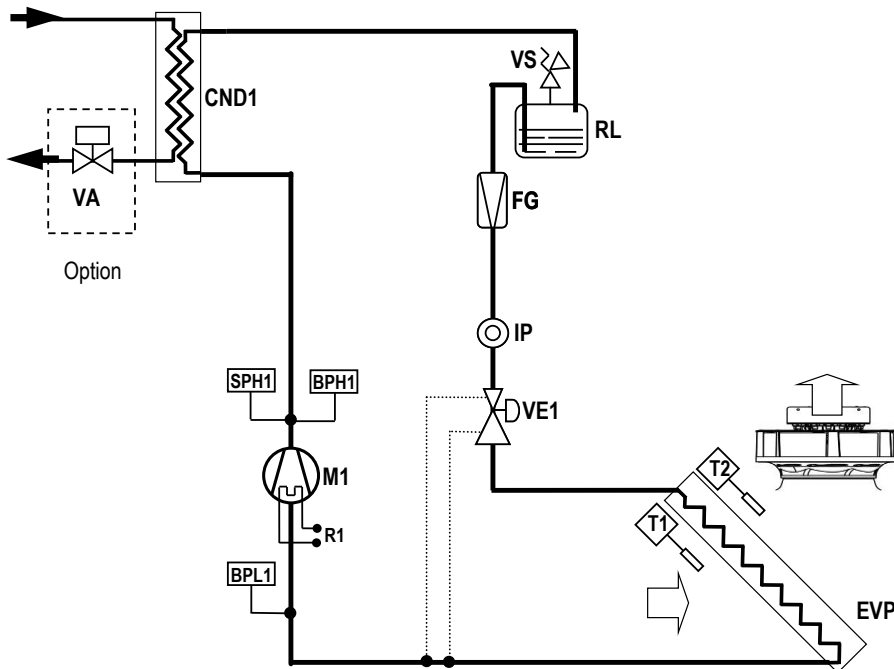

**LEGENDA**

- |     |                           |     |                          |    |   |
|-----|---------------------------|-----|--------------------------|----|---|
| M1  | BLDC inverter compressor  | BPL | Low pressure transducer. | IP | Sight glass.                                    |
| R1  | Crankcase heater          | SPH | High pressure switch     | VE | Expansion valve.                                |
| CND | Condenser.                | VS  | Safety valve.            | T  | Temperature probes.                             |
| EVP | Evaporator.               | FG  | Refrigerant filter.      | RL | Liquid receiver                                 |
| BPH | High pressure transducer. |     |                          | VA | Motorized valve for condensing control (option) |



**UNDER - DOUBLE REFRIGERANT CIRCUIT**

SIZE E9

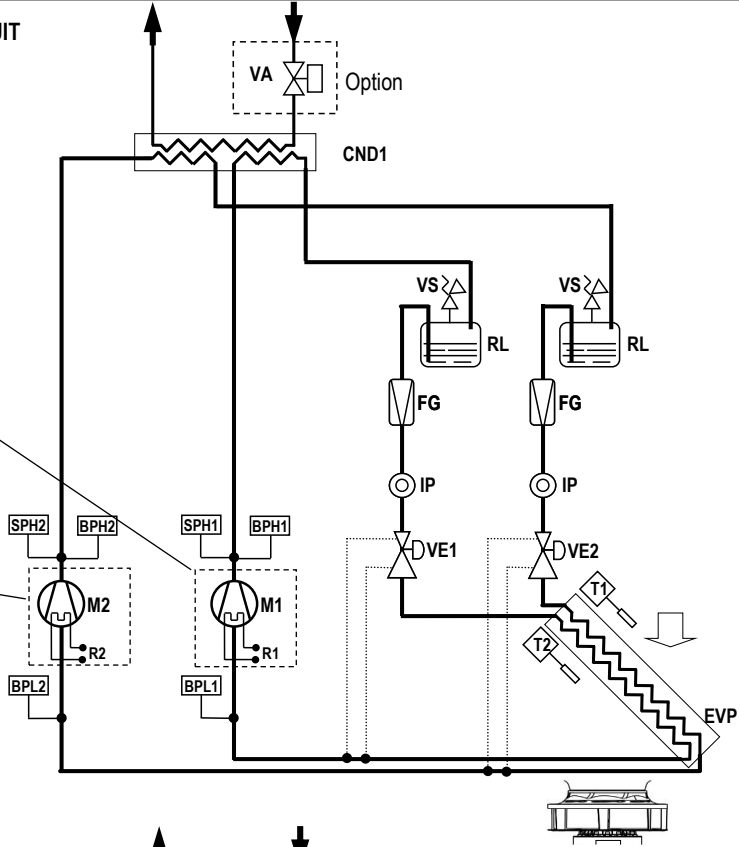
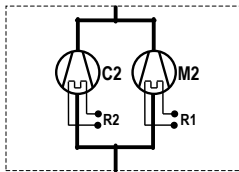
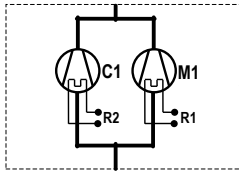

**OVER - DOUBLE REFRIGERANT CIRCUIT**

SIZE E9

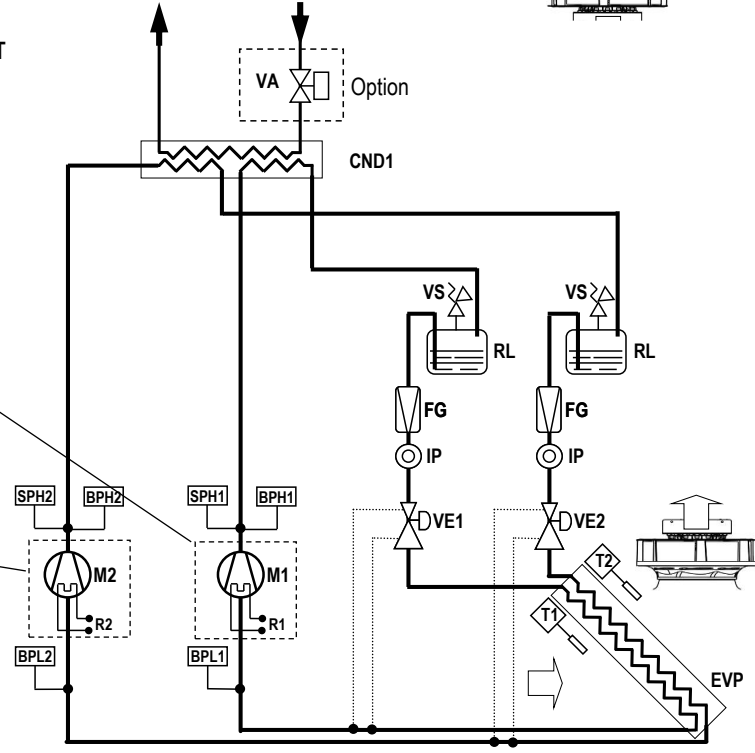
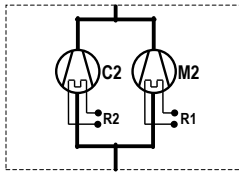
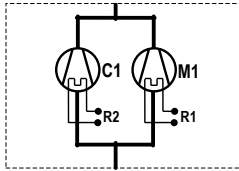

**LEGENDA**

- M1...2 BLDC inverter compressor 1, 2
- C1...2 on/off compressor 1, 2
- R1...2 Crankcase heater 1, 2
- CND Condenser.
- EVP Evaporator.
- BPH High pressure transducer.

- BPL Low pressure transducer.
- SPH High pressure switch
- VS Safety valve.
- FG Refrigerant filter.

- IP Sight glass.
- VE Expansion valve.
- T Temperature probes.
- RL Liquid receiver
- VA Motorized valve for condensing control



## ACOUSTIC DATA

Acoustic data of the standard machine at full load working conditions.

### WARNING:

In a closed room the noise produced by a sound source reaches the listener in two different ways:

- Directly
- Reflected from the surrounding walls, floor, ceiling, from furniture.

With the same sound source, the noise produced in a closed room is greater than that produced outdoors. In fact, the sound pressure level generated by the source, must be added to the one reflected from the room. Also, the shape of the room affects the sound.

### i-NEXT DW Over / Under

MODEL	012 M1 S				018 M1 S		
SIZE	E1				E2		
COOLING CAPACITY	cps	Min	Nom	Max	Min	Nom	Max
<b>SOUND LEVEL ISO 3744 (1)</b>							
On air delivery Under	dB(A)	55,5	64,0	64,7	57,7	71,4	71,4
On air intake Under	dB(A)	49,4	55,2	55,9	44,9	57,1	57,1
On front side Under	dB(A)	40,4	46,0	46,6	35,6	47,6	47,6
On air delivery Over	dB(A)	55,5	64,0	64,7	57,7	71,4	71,4
On air intake Over (2)	dB(A)	55,1	53,0	53,4	43,9	46,8	46,8
On front side Over (3)	dB(A)	39,8	45,5	46,2	31,9	40,2	40,2
MODEL	022 M1 S				030 M1 S		
SIZE	E3				E4L		
COOLING CAPACITY	cps	Min	Nom	Max	Min	Nom	Max
<b>SOUND LEVEL ISO 3744 (1)</b>							
On air delivery Under	dB(A)	57,7	68,0	69,6	61,1	74,8	81,1
On air intake Under	dB(A)	45,5	54,0	55,6	48,0	60,7	66,9
On front side Under	dB(A)	36,3	44,5	46,0	38,6	51,1	57,4
On air delivery Over	dB(A)	57,7	68,0	69,6	61,1	74,8	81,1
On air intake Over (2)	dB(A)	45,5	48,2	49,1	45,8	52,2	57,8
On front side Over (3)	dB(A)	34,1	41,2	42,8	35,1	47,2	53,4
MODEL	047 M1 S				042 M2 D		
SIZE	E5L				E5L		
COOLING CAPACITY	cps	Min	Nom	Max	Min	Nom	Max
<b>SOUND LEVEL ISO 3744 (1)</b>							
On air delivery Under	dB(A)	64,3	81,5	81,5	64,3	81,5	81,5
On air intake Under	dB(A)	52,4	68,9	68,9	52,2	68,9	68,9
On front side Under	dB(A)	43,1	59,4	59,4	42,8	59,4	59,4
On air delivery Over	dB(A)	64,3	81,5	81,5	64,3	81,5	81,5
On air intake Over (2)	dB(A)	50,3	63,5	63,5	49,4	63,5	63,5
On front side Over (3)	dB(A)	42,4	59,4	59,4	42,3	59,4	59,4
MODEL	068 M2 D				094 M2 D		
SIZE	E7L				E8L		
COOLING CAPACITY	cps	Min	Nom	Max	Min	Nom	Max
<b>SOUND LEVEL ISO 3744 (1)</b>							
On air delivery Under	dB(A)	57,4	77,2	80,1	62,8	82,5	82,5
On air intake Under	dB(A)	47,5	64,6	67,5	52,0	69,9	69,9
On front side Under	dB(A)	38,4	55,2	58,1	42,7	60,4	60,4
On air delivery Over	dB(A)	57,4	77,2	80,1	62,8	82,5	82,5
On air intake Over (2)	dB(A)	48,7	59,5	62,2	52,0	64,6	64,6
On front side Over (3)	dB(A)	37,5	55,2	58,1	41,7	60,4	60,4

1. Noise pressure level at 1 meter in free field – ISO 3744
2. Air intake from the front
3. Air intake from the bottom

## i-NEXT DW Under

MODELLO		120 M4 D (*)			150 M4 D (*)		
GRANDEZZA		E9L			E9L		
POTENZA FRIGORIFERA	cps	Min	Nom	Max	Min	Nom	Max
<b>LIVELLO SONORO ISO 3744 (1)</b>							
On air delivery Under	dB(A)	58,1	83,4	83,4	63,7	83,4	83,4
On air intake Under	dB(A)	57,5	70,9	70,9	58,2	70,9	70,9
On front side Under	dB(A)	48,9	61,5	61,5	49,5	61,5	61,5

1. Noise pressure level at 1 meter in free field – ISO 3744

(\*) Only UNDER version

## ELECTRICAL DATA

### i-NEXT DW Over / Under

MODEL		012 M1 S	018 M1 S	022 M1 S	030 M1 S	047 M1 S
SIZE		E1	E2	E3	E4L	E5L
Power supply	V/ph/Hz	400/3/50+N	400/3/50+N	400/3/50+N	400/3/50+N	400/3/50+N
Maximum current input (FLA)	A	15,3	19,7	22,2	29,2	36,4
Start-up current (SA)	A	3,3	5,3	7,8	9,2	10,8

MODEL		042 M2 D	068 M2 D	094 M2 D	120 M4 D	150 M4 D
SIZE		E5L	E7L	E8L	E9L (*)	E9L (*)
Power supply	V/ph/Hz	400/3/50+N	400/3/50+N	400/3/50+N	400/3/50+N	400/3/50+N
Maximum current input (FLA)	A	40,4	58,9	72,9	168,0	196,0
Start-up current (SA)	A	8,0	13,9	15,3	194,0	216,0

(\*) Only UNDER version

### **WARNING:**

The electric data indicated refer only to the indoor unit.

Optional accessory electric data are included within the dedicated chapters and must be added.





Please refer to ELCA WORLD selection program to calculate the electrical data of the air conditioner according to the requested optional accessories.

**MICROPROCESSOR CONTROL SYSTEM**

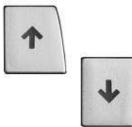

The microprocessor control system is equipped with 6 keys terminal and back lighted graphic display on which all information in different languages or easily identifiable symbols are displayed. The system disposes of a “flash” memory that preserves the information even in absence of power supply. Part of memory is dedicated to the registration of intervened events - up to 200 events.

**KEYBOARD FUNCTIONS**

	ALARM	Alarm, Back-red light active – alarm presence, push to have alarm description. If more than one alarm(s), the others can be scrolled by Key UP / DOWN
	PRG	Menu list, scrolled by key UP/DOWN: <b>Unit; Set-point; In/Out; Clock; History; User; Service; Factory.</b> Use the ENTER key to execute the mode.
	ESC	Home. Used to come back to the previous menu level or to the main screen.
	UP DOWN	Used to change the pages and values of sets. When display is in main screen (HOME), pressing one of them (UP/DOWN) will display the synoptic of the main controls.
	ENTER	Moving the cursor on adjustable Program(s) fields, to confirm the changes, press the key (ENTER) to get out of the fields.

**CONNECTIVITY**

Through the optional serial port, the microprocessor control enables communication with the modern buildings BMS systems with the following protocols:

- MBUS/JBUS (RS485) serial card;
- MBUS/JBUS (RS232) for GSM modem serial card;
- LON Works serial card;
- BACnet per Ethernet – SNMP – TCP/IP serial card;
- BACnet per MS/TP serial card;

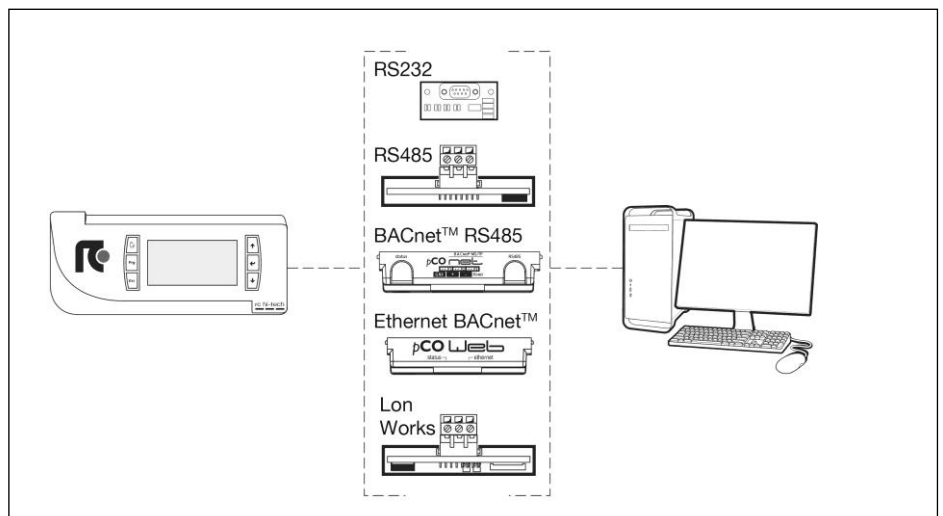

**PASSWORD**

- Level 1: On request of the End User. Allowing to reach USER menu
- Level 2: Asks to MEHITS Service: Allowing to reach SERVICE menu
- Level 3: Asks to MEHITS Service: Allowing to reach FACTORY menu

No passwords request to enter: UNIT, SETPOINT, IN/OUT, CLOCK, HISTORY menu

**LAN NETWORK**

The LAN is part of the control software and it is possible to connect up to 10 units.  
 This type of connection allows to control the units in coherent way, moreover the units can be controlled and managed from a shared remote terminal.  
 Electrical connections are on electrical panel connecting terminals.

**LAN ADDRESS LIST**

Unit #	1	2	3	4	5	6	7	8	9	10	Remote Terminal
Terminal address	1	2	3	4	5	6	7	8	9	10	32
Mother board address	11	12	13	14	15	16	17	18	19	20	-

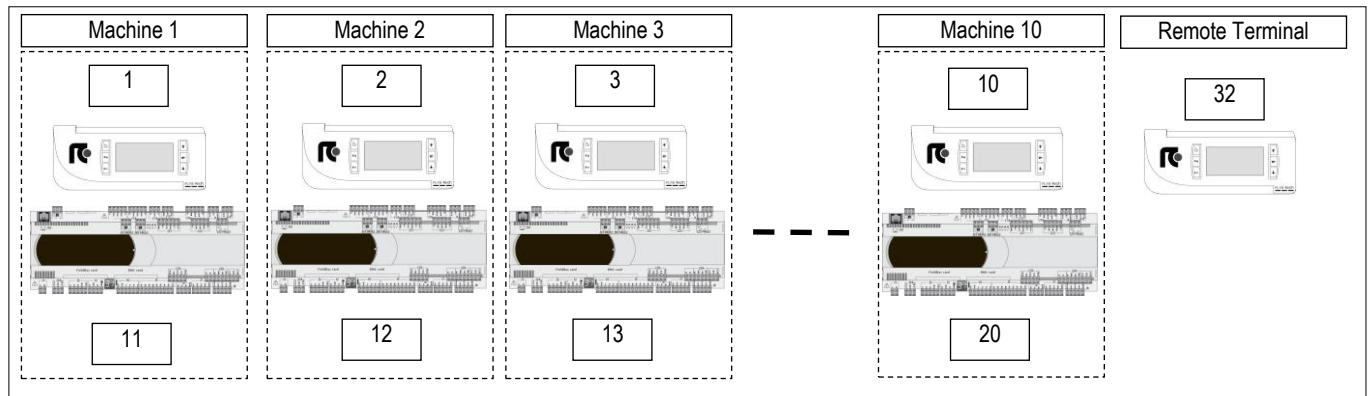

The unit connection to the local network (LAN) allows to perform the following functions:

- Balancing the operating hours among the different units by rotating the reserve units (Stand-by)
- Turning on the reserve units in case other units should turn off due to an alarm, maintenance or power feed interruption
- Turning on reserve units to offset the excessive thermal load
- Checking up to 10 units with a single user terminal (shared user terminal)

**DEMAND LIMIT**

Demand Limit function is part of the control software for machines with double refrigerant circuit. It allows to limit the absorbed current of the machine.

The function must be activated and configured. A digital inlet on electrical panel connecting terminals allows the remote enabling of the function with an external signal.

The software allows to select the resources to disable (compressors, electric heaters,...).

## POSSIBLE AIR INTAKE FOR OVER VERSIONS

### OVER VERSION - AIR INTAKE FROM THE BOTTOM

Thanks to the particular basement design, it is possible to have the intake from the bottom side. The air flow is equal to the nominal.

With this solution, it is necessary to foresee the optional blind frontal panels

### OVER VERSION - AIR INTAKE FROM THE BACK SIDE

(Sizes E4L, E5L, E6L, E7L, E8L, E9L excluded)

It is possible to have the unit air intake from the back side.

Due to the limited size of the air intake, the air flow is limited to the 20% of the nominal one.

The air intake has to be made by Customer during installation.

In case the air intake is used for fresh air, it is necessary the temperature / humidity probe reposition in front of the heat exchanger, to allow for optimum reading of the values of temperature / humidity.

The electric cable of the probe has sufficient length for the repositioning.

### AIR INTAKE FROM THE BACK SIDE

Back side view

i-NEXT DW OVER  
E1 - E2 - E3

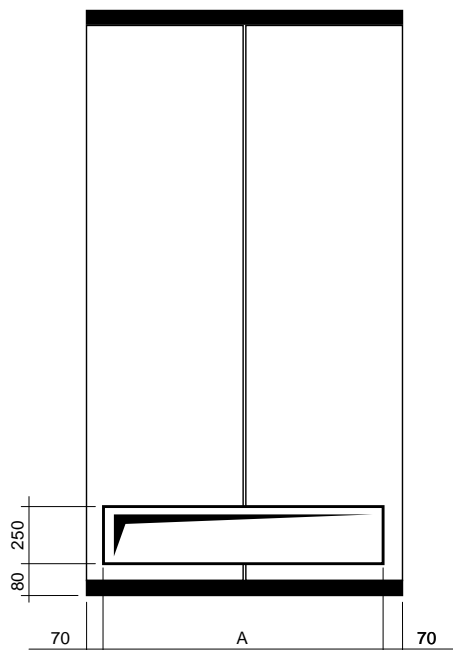

i-NEXT DW OVER		E1	E2	E3
A	mm	510	645	945
Max air flow	m <sup>3</sup> /h	600	1000	1500

**OPTIONAL ACCESSORIES – DOUBLE POWER SUPPLY WITH AUTOMATIC TRANSFER SWITCH**



The optional is not compatible with “oversized electric heaters” and “oversized humidifier” optional accessories.

The motorised changeover switches automatically manage changeover under load between two three-phase power supplies, or manually for emergency operations.

These transfer switching (TSE) devices are suitable for low voltage systems with interruption of the supply to the load during transfer.

The model supplied in the automatic version checks the source and switches over automatically, based on configurable parameters.

**OPEN TRANSITION TYPE TRANSFER SWITCH WITH A MINIMUM INTERRUPTION OF THE SUPPLY DURING TRANSFER.**

To maintain the microprocessor powered and avoid its restarts is mandatory to foresee the installation of the “temporary microprocessor power supply” optional accessory. The system guarantees the microprocessor power supply for a few minutes, in case of supply voltage failure.

The remote condenser must be powered by the automatic transfer switch. The installation of “Electrical power supply for remote condenser from the indoor machine electrical board” optional accessory is requested.

**ATS INSTALLATION**

Frame	Power Supply	ATS Installation
E1	400/3/50+N	EXTERNAL, supplied in kit
E2	400/3/50+N	EXTERNAL, supplied in kit
E3	400/3/50+N	EXTERNAL, supplied in kit
E4L	400/3/50+N	EXTERNAL, supplied in kit
E5L	400/3/50+N	EXTERNAL, supplied in kit
E7L	400/3/50+N	INTERNAL (on unit electrical panel)
E8L	400/3/50+N	INTERNAL (on unit electrical panel)
E9L	400/3/50+N	INTERNAL (on unit electrical panel)



**KIT FOR EXTERNAL INSTALLATION**

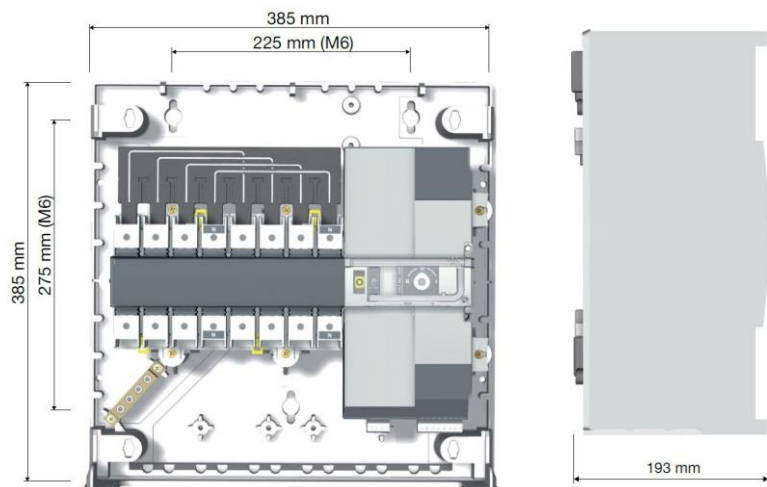



## OPTIONAL ACCESSORIES – NETWORK ANALYZER



The optional is not compatible with “oversized electric heaters” and “oversized humidifier” optional accessories.

The optional is installed within the electrical box downstream the main switch with door safety lock:

- Network transducer;
- Current transformers, one for each power supply phase cable.

This device provides continuous measurement of power consumption, monitoring current, voltage and power. These values are sent to unit microprocessor via RS485 serial cable, as shown on the unit wiring diagram.

The displayed variables are:

- Phase to phase voltage, only for three-phase units;
- Phase voltage (phase-neutral);
- Phase current;
- Neutral current only for three-phase units;
- Active phase power, only for three-phase units;
- Total active power;
- Active energy;
- Hour counts

## OPTIONAL ACCESSORIES – FIRE / SMOKE SENSORS

Is possible to install one or both of the following sensors. Sensors are supplied in mounting kit. Installation within the room at customer care.



### SMOKE DETECTOR

The optical smoke detector senses the presence of combustion by-products (visible smoke) and activates an alarm.

The operating principle is based on the light scattering technique (Tyndall effect).

The device is in conformity to EN 54-7 standard.

Technical features:

Material	ABS
Power supply	12...28 Vdc
Normal current	50µA a 24 Vdc
Alarm current	25mA a 24 Vdc
LED visibility	360° (double led)
Storage temperature	-10...+70°C
Operating temperature	-10...+70°C
Max. speed air	0,2 m/s
Relative humidity	<93% not-condensing
Index of protection	IP 20
Testing by magnet	Yes
Relay	max. 1A 30Vdc
Signal repeater	14mA a 24 Vdc
Sensor coverage:	40m <sup>2</sup> max
Shielded connection cable	sez. min 0,5 mm <sup>2</sup>
Colour	White

### WARNING:

For correct detector operation, periodical maintenance must be performed.



### HEAT DETECTOR

The heat detector has been designed to identify temperatures at which fires may start. When the temperature exceeds the set threshold or when there is a rapid variation in temperature, the relay is activated to signal an alarm.

The device is in conformity to EN 54-5 standard.

Technical features:

Material	ABS
Power supply	12...28 Vdc
Normal current	50µA a 24 Vdc
Alarm current	25mA a 24 Vdc
LED visibility	360° (double LED)
Storage temperature	-10...+70°C
Operating temperature	-10...+70°C
Relative humidity	<93% non-condensing
Index of protection	IP 20
Testing by magnet	Yes
Relay	max. 1A 30Vdc
Signal repeater	14mA a 24 Vdc
Alarm temperature threshold	62°C
Sensor coverage:	40m <sup>2</sup> max
Shielded connection cable	min 0.5 mm <sup>2</sup>
Colour	White

### WARNING:

For correct detector operation, periodical maintenance must be performed.

**OPTIONAL ACCESSORIES - CONDENSATE DISCHARGE PUMP**



A plastic case contains the vertical type pump, the water tank with float plus safety switch and hydraulic and electric connection.

Together the pump 10 linear meters anti-crushing plastic discharge spiral tube is supplied

The optional has to be installed as shown in the documentation delivered together with the unit.

Wiring includes power supply and an alarm, displayed on microprocessor, that includes motor pump thermal protection and tank overflow.

The condensate discharge pump operation is fully automatic.

**WARNING**

**For all the machines the optional accessory is supplied in mounting kit.**

**TECHNICAL DATA**

Power supply: 230V~ 50Hz

Electrical data: 70W – 0,67A

Maximum water flow: 500 l/h

Maximum delivery height: 5.0 m

Sound level: 45dBA a 1 m

Maximum water temperature: 70°C

Water acidity: pH>2.5

Tray volume: 2.0 l

Protection IP 20

**CONDENSATE DISCHARGE PUMP**

(Dimensions in millimetres)

**OPERATING DATA**

Discharge head	Total lenght of discharge pipes (Ø 10 mm internal)			
	5m	10m	20m	30m
1m	380	300	240	190
2m	310	260	200	150
3m	240	200	145	110
4m	150	130	80	60
5m	30	20	0	0



**OPTIONAL ACCESSORIES – MODULATING STEAM HUMIDIFIER**



Modulating steam humidifier with immersed electrodes fitted with safety and running accessories. The optional includes the combined temperature / humidity sensor on unit air intake. The accessory is factory installed and requires only water filling connection.

**Humidifier water charge and discharge pipes are not supplied.**

It is recommended to install a filter and a shut-off valve on the pipe to the water inlet.

This humidifier produces non-pressurized steam by electrodes immersed in the water inside the cylinder: they bring the electric phase in the water that works as an electrical resistance and overheats. The steam so produced is distributed with dedicated distributors and used for ambient humidification or for industrial processes.

**CHARACTERISTICS OF THE SUPPLY WATER**

The quality of the used water influences the evaporation process, so the humidifier can be fed with **not-treated water, only when potable and non-demineralised.**

**LIMIT VALUES**

		<b>Min</b>	<b>Max</b>
Hydrogen ions	pH	7	8,5
Specific conductivity at 20°C	$\sigma_{R, 20^\circ C}$ $\mu S/cm$	300	1250
Total dissolved solids	TDS mg/l	(1)	(1)
Dry residue at 180°C	R <sub>180</sub> mg/l	(1)	(1)
Total hardness	TH mg/l CaCO <sub>3</sub>	100 (2)	400
Temporary hardness	mg/l CaCO <sub>3</sub>	60 (3)	300
Iron + Manganese	mg/l Fe + Mn	0	0,2
Chlorides	ppm Cl	0	30
Silica	mg/l SiO <sub>2</sub>	0	20
Residual chlorine	mg/l Cl <sup>-</sup>	0	0,2
Calcium sulphate	mg/l CaSO <sub>4</sub>	0	100
Metallic impurities	mg/l	0	0
Solvents, diluents, soaps, lubricants	mg/l	0	0

(1) Values depending on specific conductivity;

in general: TDS  $\cong 0,93 * \sigma_{R, 20^\circ C}$ ; R<sub>180</sub>  $\cong 0,65 * \sigma_{R}$

(2) Not lower than 200% of the chloride content in mg/l di Cl<sup>-</sup>

(3) Not lower than 300% of the chloride content in mg/l di Cl<sup>-</sup>

**WARNING:**

- No relation can be demonstrated between water hardness and conductivity.
- **Do not treat water with softeners!** This could cause corrosion of the electrodes or the formation of foam, leading to potential operating problems or failures.
- Do not add disinfectants or corrosion inhibitors to water, as these substances are potentially irritant.
- Is absolutely forbidden to use well water, industrial water or water drawn from cooling circuits; in general, avoid using potentially contaminated water, either from a chemical or bacteriological point of view

**TECHNICAL DATA HUMIDIFIER – i-NEXT DW Over / Under**

MODEL		012 M1 S	018 M1 S	022 M1 S	030 M1 S	047 M1 S
<b>SIZE</b>		<b>E1</b>	<b>E2</b>	<b>E3</b>	<b>E4L</b>	<b>E5L</b>
<b>VAPOUR PRODUCTION</b>	<b>kg/h</b>	<b>3,0</b>	<b>3,0</b>	<b>3,0</b>	<b>8,0</b>	<b>8,0</b>
Power input	kW	2,3	2,3	2,3	6,0	6,0
Absorbed current (OA)	A	3,2	3,2	3,2	8,7	8,7
Max absorbed current (OA)	A	4,5	4,5	4,5	12,4	12,4
Water content	l	3,9	3,9	3,9	6,4	6,4
Max water supply pressure	Bar	1÷8	1÷8	1÷8	1÷8	1÷8
<b>NET WEIGHT (1)</b>	<b>kg</b>	<b>4</b>	<b>4</b>	<b>4</b>	<b>10</b>	<b>10</b>
<b>HYDRAULIC CONNECTION</b>						
INGRESSO ACQUA - ISO 228/1 – G F	Ø	3/4"	3/4"	3/4"	-	-
INGRESSO ACQUA - ISO 228/1 – G M	Ø	-	-	-	3/4"	3/4"
USCITA ACQUA – diametro interno	Ø mm	19	19	19	-	-
USCITA ACQUA – diametro esterno	Ø mm	-	-	-	19	19

1. Value to be added to the weight of the standard unit. Does not include the weight of the water content.

**TECHNICAL DATA HUMIDIFIER – i-NEXT DW Over / Under**



MODEL		042 M2 D	068 M2 D	094 M2 D	120 M4 D (*)	150 M4 D (*)
<b>SIZE</b>		<b>E5L</b>	<b>E7L</b>	<b>E8L</b>	<b>E9L</b>	<b>E9L</b>
<b>VAPOUR PRODUCTION</b>	<b>kg/h</b>	<b>8,0</b>	<b>8,0</b>	<b>8,0</b>	<b>8,0</b>	<b>8,0</b>
Power input	kW	6,0	6,0	6,0	6,0	6,0
Absorbed current (OA)	A	8,7	8,7	8,7	8,7	8,7
Max absorbed current (OA)		12,4	12,4	12,4	12,4	12,4
Water content	l	6,4	6,4	6,4	6,4	6,4
Max water supply pressure	Bar	1÷8	1÷8	1÷8	1÷8	1÷8
<b>NET WEIGHT (1)</b>	<b>kg</b>	<b>10</b>	<b>10</b>	<b>10</b>	<b>10</b>	<b>10</b>
<b>HYDRAULIC CONNECTION</b>						
WATER INLET - ISO 228/1 – G F	Ø	-	-	-	-	-
WATER INLET - ISO 228/1 – G M	Ø	3/4"	3/4"	3/4"	3/4"	3/4"
WATER OUTLET – internal diameter	Ø mm	-	-	-	-	-
WATER OUTLET – external diameter	Ø mm	19	19	19	19	19

1. Value to be added to the weight of the standard unit. Does not include the weight of the water content.

(\*) Only UNDER version

#### OVERSIZED HUMIDIFIERS

The optional is not available for size E1, E2, E3, E4L, E5L.

On request, it is possible to install the oversized humidifiers system.

The components are the same of the standard accessory

#### TECHNICAL DATA OVERSIZED HUMIDIFIER – i-NEXT DW Over / Under

MODEL		068 M2 D	094 M2 D	120 M4 D (*)	150 M4 D (*)
<b>SIZE</b>		<b>E7L</b>	<b>E8L</b>	<b>E9L</b>	<b>E9L</b>
<b>VAPOUR PRODUCTION</b>	<b>kg/h</b>	<b>15,0</b>	<b>15,0</b>	<b>15,0</b>	<b>15,0</b>
Power input	kW	11,3	11,3	11,3	11,3
Absorbed current (OA)	A	16,2	16,2	16,2	16,2
Max absorbed current (FLA)	A	23	23	23	23
Water content	l	10,3	10,3	10,3	10,3
Max water supply pressure	Bar	1÷8	1÷8	1÷8	1÷8
<b>NET WEIGHT (1)</b>	<b>kg</b>	<b>16</b>	<b>16</b>	<b>16</b>	<b>16</b>
<b>HYDRAULIC CONNECTION</b>					
WATER INLET - ISO 228/1 – G F	Ø	-	-	-	-
WATER INLET - ISO 228/1 – G M	Ø	3/4"	3/4"	3/4"	3/4"
WATER OUTLET - internal diameter	Ø mm	-	-	-	-
WATER OUTLET - external diameter	Ø mm	19	19	19	19

1. Value to be added to the weight of the standard unit. Does not include the weight of the water content.

(\*) Only UNDER version

#### OPTIONAL ACCESSORIES – DEHUMIDIFICATION SYSTEM

Components:

- Temperature / Humidity sensor on the air intake.
- Electronic control system of the dew point temperature for the combined intervention of cooling capacity and air flow.



**OPTIONAL ACCESSORIES - 2-WAY MOTORIZED VALVE FOR CONDENSING CONTROL**

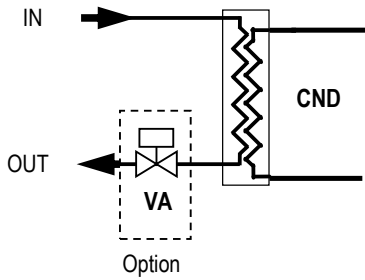

CND Condenser  
VA Condensing control valve

The optional accessory, installed on the condenser outlet side, includes a 2-way motorized valve for condensing control with 0÷10 VDC control actuator and emergency manual control.

The water flow control in the condenser is achieved through a 2-way modulating ball valve with equal percentage flow control ensured by the integrated characterizing disc.

This type of valve offers the following series of benefits:

- Equal percentage flow control.
- Closing seal with leakage rate in Class A (EN 12266-1)
- No peaks initial flow.
- Excellent stability control thanks to the integrated characterizing disc.
- Closing pressure very high.
- Excellent characteristic in partialisation.
- Stability in control.
- Wide operating pressures which provide an optimal adjustment of the water flow even under extreme conditions.
- Maintenance free.
- Self-cleaning.

The rotative actuator is controlled by a signal 0 ... 10VDC from the microprocessor controller. The actuator is equipped with an emergency button for manual operation and is maintenance-free.

**TECHNICAL DATA – i-NEXT DW**

MODEL		012 M1 S	018 M1 S	022 M1 S	030 M1 S	047 M1 S
SIZE		E1	E2	E3	E4L	E5L
<b>CONDENSING CONTROL VALVE</b>						
$k_v$ – Flow coefficient	m <sup>3</sup> /h	4,0	6,3	6,3	10,0	10,0

MODEL		042 M2 D	068 M2 D	094 M2 D	120 M4 D (*)	150 M4 D (*)
SIZE		E5L	E7L	E8L	E9L	E9L
<b>CONDENSING CONTROL VALVE</b>						
$k_v$ – Flow coefficient	m <sup>3</sup> /h	16,0	25,0	25,0	40,0	40,0

(\*) solo versione UNDER.

**IMPORTANT**

For further information, please refer to chapter “VALVE PRESSURE DROP CALCULATION AS FUNCTION OF WATER FLOW RATE”



## OPTIONAL ACCESSORIES – ELECTRIC HEATERS



Electric heater consisting of finned aluminum elements, ensuring low surface temperature and deleting the air ionization problems. The optional is installed downstream the main cooling coil.

In electric heaters with three working steps the activation is binary type.

Components:

- Electric heater in aluminium armoured elements with integral fins
- Electrical control
- Safety thermostat.

### TECHNICAL DATA ELECTRIC HEATERS – i-NEXT DW Over / Under

MODEL		012 M1 S	018 M1 S	022 M1 S	030 M1 S	047 M1 S
SIZE		E1	E2	E3	E4L	E5L
<b>THERMAL CAPACITY</b>	<b>kW</b>	<b>6,0</b>	<b>6,0</b>	<b>6,0</b>	<b>9,0</b>	<b>12,0</b>
Absorbed current (OA)	A	8,7	8,7	8,7	13,0	17,3
First working step	kW	6,0	6,0	3,9	3,0	4,5
Second working step	kW	-	-	6,0	6,0	9,0
Third working step	kW	-	-	-	3,0 + 6,0	4,5 + 9,0
<b>NET WEIGHT (1)</b>	<b>kg</b>	<b>5</b>	<b>5</b>	<b>10</b>	<b>15</b>	<b>21</b>

MODEL		042 M2 D	068 M2 D	094 M2 D	120 M4 D (*)	150 M4 D (*)
SIZE		E5L	E7L	E8L	E9L	E9L
<b>THERMAL CAPACITY</b>	<b>kW</b>	<b>12,0</b>	<b>12,0</b>	<b>18,0</b>	<b>18,0</b>	<b>18,0</b>
Absorbed current (OA)	A	17,3	17,3	26,0	26,0	26,0
First working step	kW	4,5	4,5	6,0	6,0	6,0
Second working step	kW	9,0	9,0	12,0	12,0	12,0
Third working step	kW	4,5 + 9,0	4,5 + 9,0	6,0 + 12,0	6,0 + 12,0	6,0 + 12,0
<b>NET WEIGHT (1)</b>	<b>kg</b>	<b>21</b>	<b>21</b>	<b>23</b>	<b>30</b>	<b>30</b>

1. Value to be added to the weight of the standard unit.

(\*) Only UNDER version

### OVERSIZED ELECTRIC HEATERS

The optional is not available for size E1, E2

On request, it is possible to install the oversized electric heating system.

The components are the same of the standard accessory

### TECHNICAL DATA OVERSIZED ELECTRIC HEATERS – i-NEXT DW

MODEL		012 M1 S	018 M1 S	022 M1 S	030 M1 S	047 M1 S
SIZE		E1	E2	E3	E4L	E5L
<b>THERMAL CAPACITY</b>	<b>kW</b>	<b>-</b>	<b>-</b>	<b>9,0</b>	<b>12,0</b>	<b>18,0</b>
Absorbed current (OA)	A	-	-	13,0	17,3	26,0
First working step	kW	-	-	6,0	4,2	6,3
Second working step	kW	-	-	9,0	7,8	11,7
Third working step	kW	-	-	-	4,2+7,8	6,3+11,7
<b>NET WEIGHT (1)</b>	<b>kg</b>	<b>-</b>	<b>-</b>	<b>15</b>	<b>18</b>	<b>25</b>

MODEL		042 M2 D	068 M2 D	094 M2 D	120 M4 D (*)	150 M4 D (*)
SIZE		E5L	E7L	E8L	E9L	E9L
<b>THERMAL CAPACITY</b>	<b>kW</b>	<b>18,0</b>	<b>18,0</b>	<b>27,0</b>	<b>27,0</b>	<b>27,0</b>
Absorbed current (OA)	A	26,0	26,0	39,0	39,0	39,0
First working step	kW	6,3	6,3	9,0	9,0	9,0
Second working step	kW	11,7	11,7	18,0	18,0	18,0
Third working step	kW	6,3+11,7	6,3+11,7	9,0+18,0	9,0+18,0	9,0+18,0
<b>NET WEIGHT (1)</b>	<b>kg</b>	<b>25</b>	<b>25</b>	<b>38</b>	<b>38</b>	<b>38</b>

1. Value to be added to the weight of the standard unit.

(\*) Only UNDER version

**OPTIONAL ACCESSORIES - HOT GAS RE-HEATING SYSTEM**



On-off type hot gas re-heating system.  
 The optional is not compatible with "electric heaters".  
 In presence of normal or extraordinary variations of the room thermal load, it can be necessary to control an increase in the relative humidity value, by adding sensible heat to the pre-cooled and pre-dehumidified air.  
 To achieve this result, it is possible to take advantage of part of the heat of condensation given by the operation of the cooling circuit which has to be dissipated anyway.  
 This system is energy conscious since it does not require any other electric energy but that already consumed by the compressor.  
 The necessary heat is obtained by the partial deviation of the compressor hot gas discharge into heat exchange coil, installed downstream the cooling coil, so that heat is transferred to the air being handled.  
 The gas is then brought back into the main circuit via the dissipation system (air cooled or water-cooled condenser).  
 It is equipped with ON/OFF control of the quantity of heat provided by the re-heating coil.  
 The system looks like a derivation of the main gas circuit and it is formed by a 4-way valve positioned on the compressor discharge side.  
 Heat transfer is achieved through a heat exchanger placed immediately after the evaporating coil.  
 Upon a re-heating request from the microprocessor control system, the 4 way valve divert the hot gas through the re-heating coil.  
 This causes a temperature increase in the leaving air from the evaporating coil.  
 The refrigerant gas is then brought to the condenser and then back to the evaporating coil.  
 During normal working conditions, the 4-way valve does not allow the passage of the hot gas through the re-heating coil by ensuring it enters directly into the condensing system.  
 In case of failure of the 4-way valve, the valve automatically positions itself to completely exclude the re-heating system.  
**In machines with double refrigerant circuit the optional is installed on a single refrigerant circuit.**

**HOT GAS RE-HEATING SYSTEM PRINCIPLE DIAGRAM**

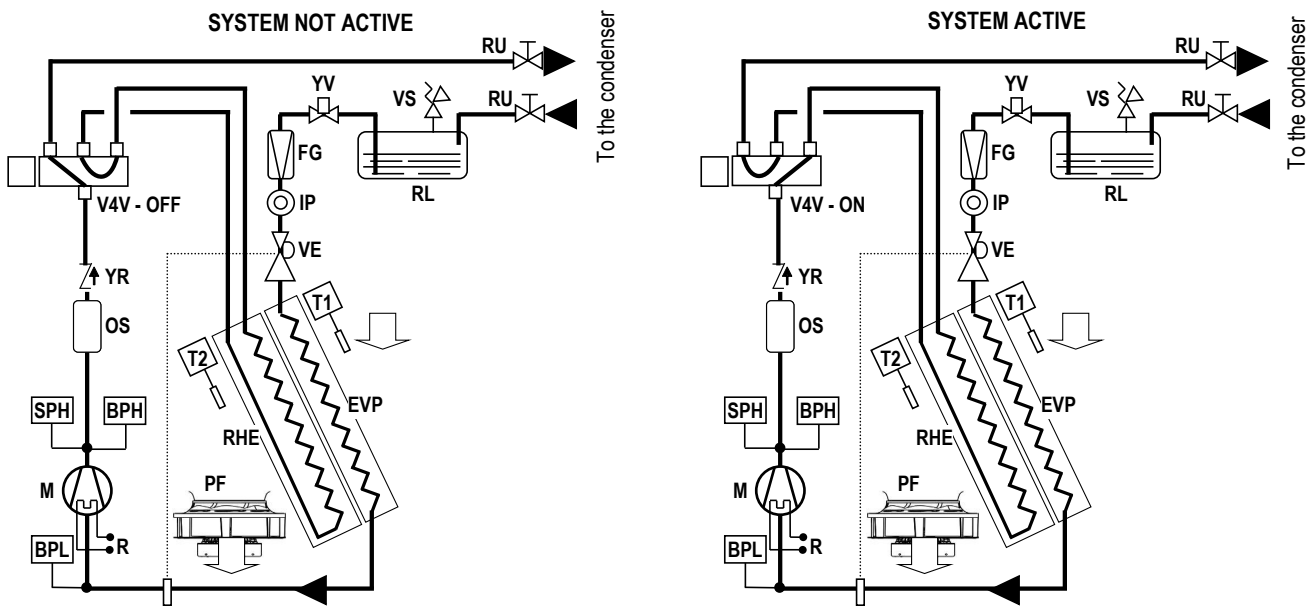

**LEGENDA:**

- |     |                                   |    |   |
|-----|-----------------------------------|----|---|
| C   | Compressor                        | OS | Oil separator                                     |
| R   | Crankcase heater                  | YR | Check valve                                       |
| EVP | Evaporator                        | PF | Plug fan  |
| RHE | Re-heating coil                   | YV | Solenoid valve (optional)                         |
| BPH | High pressure transducer          | IP | Sight glass                                       |
| BPL | Low pressure transducer           | VE | Electronic expansion valve with temperature probe |
| SPH | High pressure switch              | T  | Temperature probes                                |
| V4V | 4-way valve for re-heating system | RU | Valves  |
| VS  | Safety valve                      | RL | Liquid receiver                                   |
| FG  | Refrigerant filter                |    |   |





## TECHNICAL DATA HOT GAS REHEATING SYSTEM – i-NEXT DX Over / Under

MODEL		012 M1 S			018 M1 S		
SIZE		E1			E2		
		Min	Nom	Max	Min	Nom	Max
HEATING CAPACITY	kW	2,9	8,2	9,2	6,3	15,0	16,8

MODEL		022 M1 S			030 M1 S		
SIZE		E3			E4L		
		Min	Nom	Max	Min	Nom	Max
HEATING CAPACITY	kW	7,1	18,7	19,6	13,5	26,2	32,8

MODEL		047 M1 S			042 M2 D		
SIZE		E5L			E5L		
		Min	Nom	Max	Min	Nom	Max
HEATING CAPACITY	kW	15,5	40,3	43,3	6,8	18,9	20,7

MODEL		068 M2 D			094 M2 D		
SIZE		E7L			E8L		
		Min	Nom	Max	Min	Nom	Max
HEATING CAPACITY	kW	10,8	29,3	32,9	14,8	38,9	42,1

MODEL		120 M4 D			150 M4 D		
SIZE		E9L			E9L		
		Min	Nom	Max	Min	Nom	Max
HEATING CAPACITY	kW	14,2	47,9	49,9	16,2	55,9	58,0

The optional accessory modifies the weight of the standard unit.

## OPTIONAL ACCESSORIES - FLOOR STAND

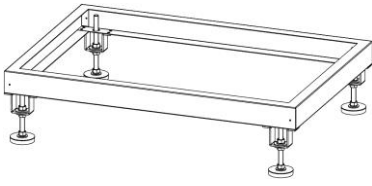

It is not possible to match the unit floor stand with plenum installed under the machine.  
 For a correct installation of the air conditioner we suggest you to utilize a gasket between the floor stand and the unit base.  
 The floor stand is available in 3 different heights.

### SIZE E1 - E2 - E3

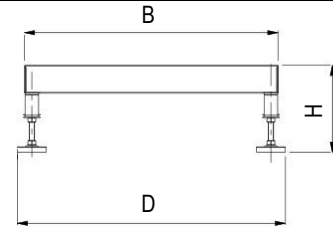
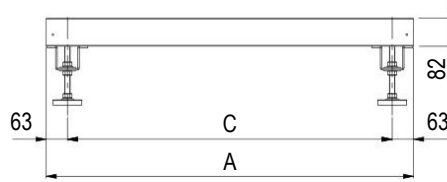

### SIZE E4L - E5L

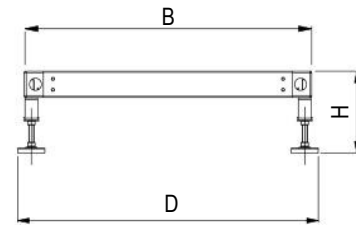
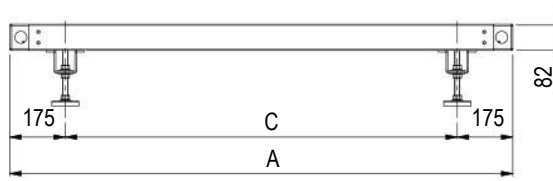

### SIZE E7L - E8L - E9L

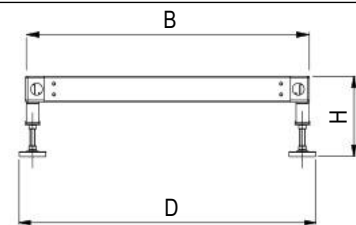
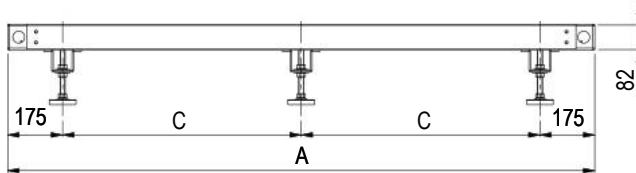

SIZE		E1	E2	E3	E4L	E5L	E7L	E8L	E9L
A	mm	650	785	1085	1630	1955	2499	2899	3299
B	mm	650	650	750	905	905	905	905	905
C	mm	524	659	959	1280	1605	1074,5	1274,5	1474,5
D	mm	691	691	791	945	945	945	945	945

MODEL		Hmax350	Hmax450	Hmax510
H min height	mm	255	355	400
H max height	mm	350	450	510

## OPTIONAL ACCESSORIES - DOUBLE PANELS IN EUROCLASS A1

The optional is designed to supply the panels only in euroclass A1 of reaction to fire, furthermore allows a noise insulation of the panels of the air conditioners.

The pressure level reduction of the unit is about 2 dB(A). The reduction refers ONLY to the sound level radiated from the unit or in front of the unit. The noise level data on return and delivery air do not undergo reductions.

The accessory includes:

- External part as standard panel.
- Internal part in galvanized steel sheet.
- The inside noise insulation with special soundproof material.

### REACTION TO FIRE CLASSIFICATION

On Italian territory, the classification is per the D.M. of June 26, 1984 and subsequent amendments, providing for a sort in "Classes" from 0 (non-combustible material) to 5 (extremely flammable material). In Europe, the classification is regulated per UNI EN 13501-1: 2009 ordered to "Euro-classes", from A1 (non-combustible material) to F (highly flammable material).

A comparison of the Italian and European classes is not possible because the methods and evaluation criteria are completely different. The comparison table below is being considered purely indicative.

Definition	Italian classes	Euro-classes
Non-combustible material	Class 0	A1
Combustible material, very limited contribution to fire	Class 1	A2 – B
Combustible material, limited contribution to fire	Class 2	A2 – B - C
Combustible material, medium contribution to fire	Class 3	C – D
Combustible material, highly contribution to fire	Class 4	E
Combustible material, easily flammable	Class 5	F

Is possible to provide the sandwich panels for the OVER units with air flow from the top. This implies that the air intake must necessarily be from the base of the unit with front blind paneling.

The accessory increase the unit weight:

OVER									
Size		E1	E2	E3	E4L	E5L	E7L	E8L	E9L
Weight increasing (1)	kg	30	42	48	64	72	100	115	--

UNDER									
Size		E1	E2	E3	E4L	E5L	E7L	E8L	E9L
Weight increasing (1)	kg	26	48	55	70	86	130	145	165

1. Add this value to the total unit weight

## OPTIONAL ACCESSORIES – M5 EFFICIENCY AIR FILTERS

The M5 air filters replace the standard one.  
The filters M5 generate a pressure drops higher than the standard ones.  
The filters are made of glass micro fibre and are not regenerable.

### i-NEXT DW Over / Under

MODEL		012 M1 S	018 M1 S	022 M1 S	030 M1 S	047 M1 S
SIZE		E1	E2	E3	E4L	E5L
Additional pressure drops (1)	Pa	48	68	43	22	34

MODEL		042 M2 D	068 M2 D	094 M2 D	120 M4 D (*)	150 M4 D (*)
SIZE		E5L	E7L	E8L	E9L	E9L
Additional pressure drops (1)	Pa	34	40	48	74	74

1. Additional pressure drops referred to nominal air flow and clean filter.
- (\*) Only UNDER version

**OPTIONAL ACCESSORIES – NON-RETURN MOTORIZED DAMPER**

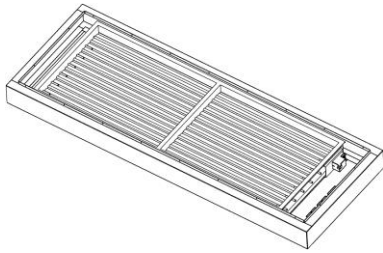

Accessory to install on units air delivery or return and it can be matched to plenums and floor stand.

**FRAMEWORK**

- Frame in galvanized steel sheet with protective surfaces treatment in compliance with UNI ISO 9227/ASTMB117 and ISO 7253, and painted with epoxy powders. Colour RAL 9005;
- Opposed blade dampers in galvanized steel sheet.
- Actuator for damper control.
- Terminals for electric connection to the unit.

For a correct installation, we suggest you to utilize a gasket between the damper and the plenum or the floor stand.

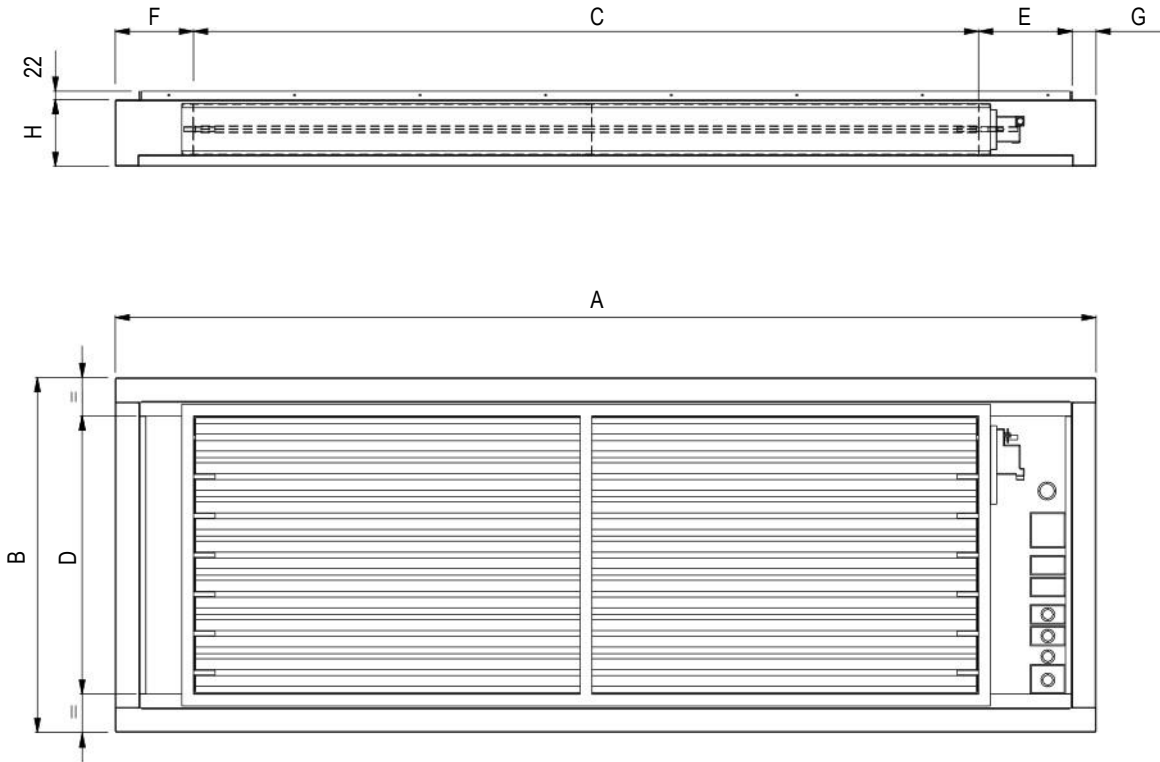

Size		E1	E2	E3	E4L	E5L	E7L	E8L	E9L (*)
A	mm	650	785	1085	1630	1955	2499	2899	3299
B	mm	650	650	750	905	905	905	905	905
C	mm	300	450	750	900	1250	1750	2000	2300
D	mm	510	510	610	710	710	710	710	710
E	mm	231	216	216	467	529	550,5	638,5	638,5
F	mm	73	73	73	202	115	137,5	199,5	299,5
G	mm	46	46	46	61	61	61	61	61
H	mm	170	170	170	170	170	170	170	170
Weight (1)	kg	20	23	30	45	55	70	80	90

1. Add this value to the total unit weight  
 (\*) Only UNDER version

## INSTALLATION EXAMPLE

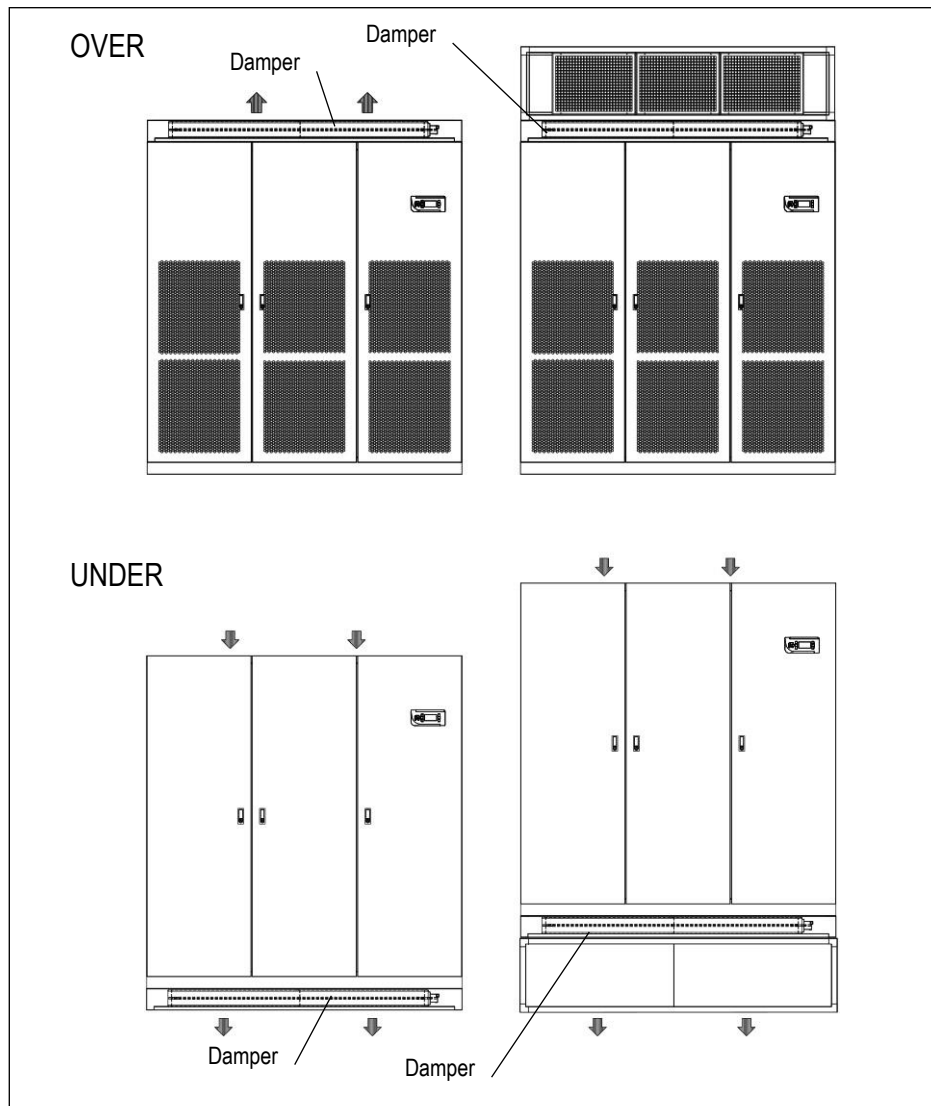

### WORKING LOGIC

The damper opens at supply fans activation to allow air flow.

When the fans stop for failure or stop command, the damper closes, preventing air flow into the unit.

## OPTIONAL ACCESSORIES - PLENUM ON AIR DELIVERY/RETURN

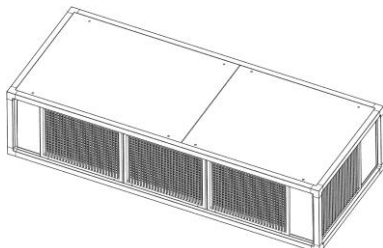
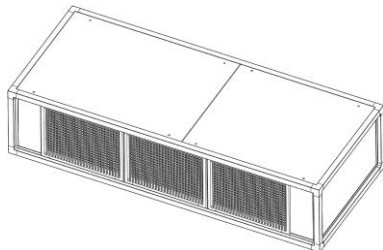
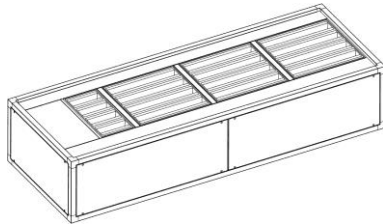
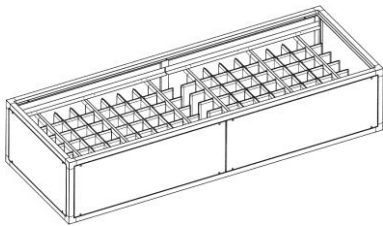
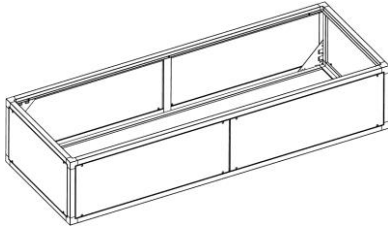

The plenums can be used for versions Over and Under, both on supply and return air. The plenums have same technical characteristics and dimensions of the machine cabinet.

**It is possible to install only a single plenum to ensure stability to the unit.**

### FRAMEWORK

- Frame in aluminium extrusion, painted with epoxy powders. Colour RAL 9005;
- Panels in galvanized steel sheet with protective surfaces treatment in compliance with UNI ISO 9227/ASTMB117 and ISO 7253, and painted with epoxy powders. Colour RAL 9005;
- Panels insulated with polyurethane foam and seals to ensure air tight.
- Panels fixed with screws.
- Removable panels.
- Set of fixing elements to fasten the plenum to the unit.

### Type of plenum:

- Empty plenum. Available in Euroclass A1.
- Plenum with noise absorption partitions
- Plenum with high efficiency filters.
- Plenum with frontal grille. Available in Euroclass A1.
- Plenum with frontal and lateral grilles. Available in Euroclass A1.
- Plenum with frontal grille and noise absorption partitions

### **WARNING**

**In UNDER version units the hydraulic piping is inside the machine.**

**The air delivery plenums sometime don't allow the extension of the pipes downwards.**

**In special cases, to keep the connections inside the machine, foresee a plenum 200mm higher than the standard one.**

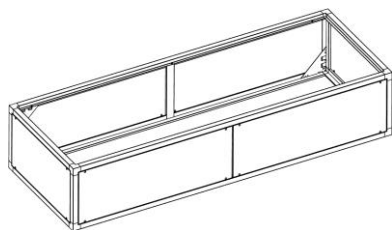

## EMPTY PLENUM

The plenum is void and can be used to rise the return air inlet/outlet.  
Remove the frontal panels for inspection.

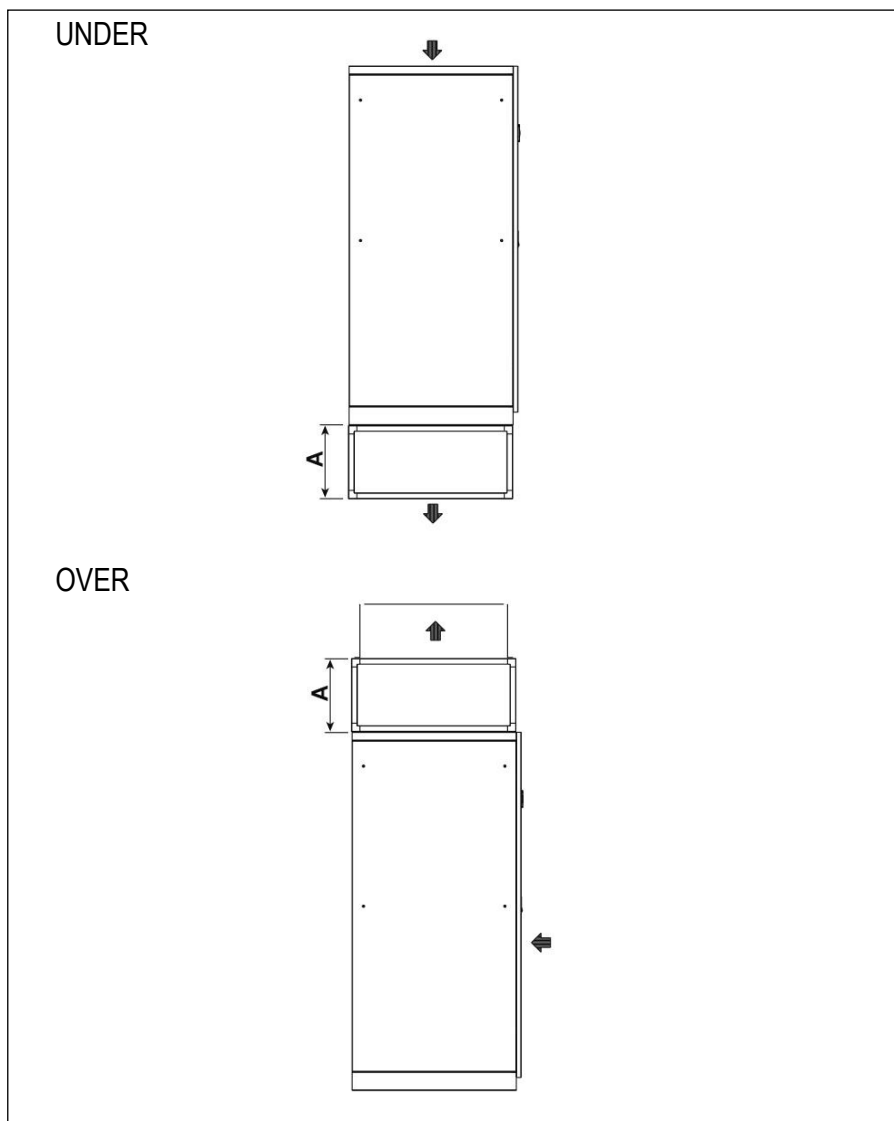

SIZE		E1	E2	E3	E4L	E5L	E7L	E8L	E9L (*)
A	mm	490	490	490	510	510	510	510	510
Weight (1)	kg	20	21	20	40	45	60	70	80

1. Add this value to the total unit weight  
(\*) Only UNDER version

## EMPTY PLENUM REACTION TO FIRE - EUROCLASS A1

SIZE		E1	E2	E3	E4L	E5L	E7L	E8L	E9L (*)
A	mm	490	490	490	510	510	510	510	510
Weight (1)	kg	25	27	27	50	56	74	85	97

1. Valore da sommare al peso complessivo dell'unità  
(\*) Solo versione UNDER

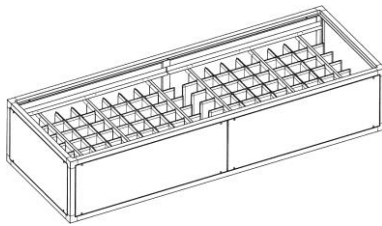

## PLENUM ON AIR DELIVERY WITH NOISE ABSORPTION PARTITIONS

The plenum is fitted with noise absorption partitions to reduce the noise emission.  
Remove the frontal panels for inspection.

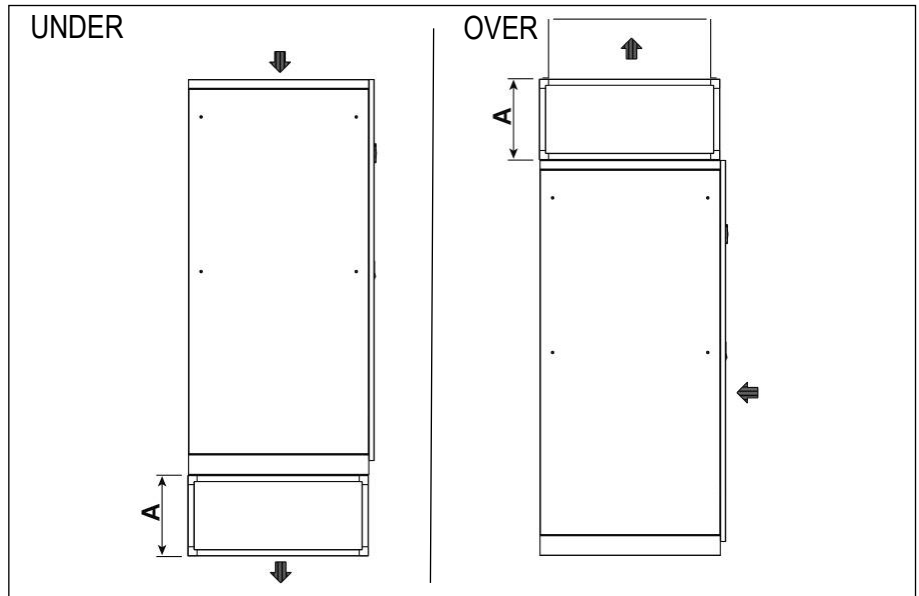

SIZE		E1	E2	E3	E4L	E5L	E7L	E8L	E9L (*)
A	mm	490	490	490	510	510	510	510	510
Weight (1)	kg	25	27	30	50	55	90	100	110

1. Add this value to the total unit weight
- (\*) Only UNDER version

## ACOUSTIC DATA – i-NEXT DW

MODEL		012 M1 S	018 M1 S	022 M1 S	030 M1 S	047 M1 S
SIZE		E1	E2	E3	E4L	E5L
<b>SOUND LEVEL ISO 3744 (1)</b>						
On air delivery, Under	dB(A)	61,0	67,3	64,1	70,5	77,1
On air intake, Under	dB(A)	55,4	57,6	54,4	60,7	68,8
On front side, Under	dB(A)	46,2	48,1	44,8	51,1	59,3
On air delivery, Over	dB(A)	61,0	60,6	61,2	66,6	77,1
On air intake, Over (2)	dB(A)	53,2	47,5	48,5	52,2	63,4
On front side, Over (3)	dB(A)	45,7	41,4	41,7	47,1	59,3
Air flow (4)	m <sup>3</sup> /h	2700	4100	5100	7500	12000

MODELLO		042 M2 D	068 M2 D	094 M2 D	120 M4 D (*)	150 M4 D (*)
GRANDEZZA		E5L	E7L	E8L	E9L	E9L
<b>LIVELLO SONORO ISO 3744 (1)</b>						
On air delivery, Under	dB(A)	77,1	73,0	78,1	79,1	79,1
On air intake, Under	dB(A)	68,8	64,6	69,7	70,9	70,9
On front side, Under	dB(A)	59,3	55,2	60,3	61,4	61,4
On air delivery, Over	dB(A)	77,1	73,0	78,1	-	-
On air intake, Over (2)	dB(A)	63,4	59,5	64,5	-	-
On front side, Over (3)	dB(A)	59,3	55,2	60,3	-	-
Air flow (4)	m <sup>3</sup> /h	12000	17500	22000	32000	32000

1. Noise pressure level at 1 meter in free field – ISO 3744
  2. Air intake from the front
  3. Air intake from the bottom
  4. Nominal air flow with noise absorption partitions plenum installation and external static pressure 20 Pa.
- (\*) Only UNDER version



**PLENUM ON AIR RETURN WITH NOISE ABSORPTION PARTITIONS**

Available only for UNDER version

The plenum is fitted with noise absorption partitions to reduce the noise emission.  
Remove the frontal panels for inspection.

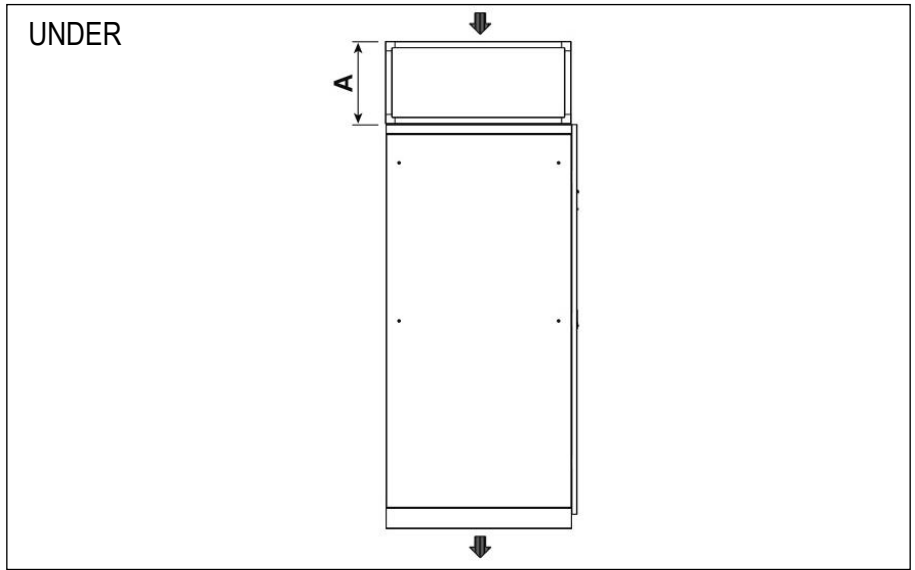
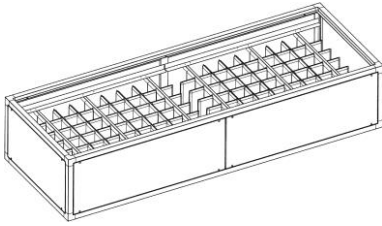

SIZE		E1	E2	E3	E4L	E5L	E7L	E8L	E9L
A	mm	490	490	490	510	510	510	510	510
Weight (1)	kg	25	27	30	50	55	90	100	110

1. Add this value to the total unit weight

**ACOUSTIC DATA – i-NEXT DW**

MODEL		012 M1 S	018 M1 S	022 M1 S	030 M1 S	047 M1 S
SIZE		E1	E2	E3	E4L	E5L
<b>SOUND LEVEL ISO 3744 (1)</b>						
On air delivery, Under	dB(A)	64,0	71,4	68,0	74,8	81,5
On air intake, Under	dB(A)	52,7	54,2	51,1	57,9	66,1
On front side, Under	dB(A)	46,0	47,6	44,5	51,1	59,4
Air flow (2)	m <sup>3</sup> /h	2700	4100	5100	7500	12000

MODEL		042 M2 D	068 M2 D	094 M2 D	120 M4 D	150 M4 D
SIZE		E5L	E7L	E8L	E9L	E9L
<b>SOUND LEVEL ISO 3744 (1)</b>						
On air delivery, Under	dB(A)	81,5	77,2	82,5	83,4	83,4
On air intake, Under	dB(A)	66,1	61,9	67,1	68,1	68,1
On front side, Under	dB(A)	59,4	55,2	60,4	61,5	61,5
Air flow (2)	m <sup>3</sup> /h	12000	17500	22000	32000	32000

1. Noise pressure level at 1 meter in free field – ISO 3744
2. Nominal air flow with noise absorption partitions plenum installation and external static pressure 20 Pa



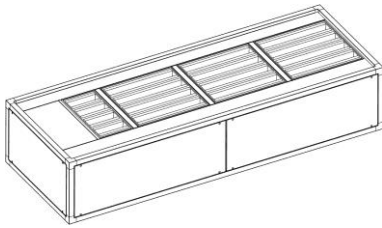

## PLENUM ON AIR DELIVERY WITH HIGH EFFICIENCY FILTERS

The plenum must be installed on air delivery.  
 The plenum is fitted with high efficiency rigid bag filters.  
 Filters are made of glass micro fibre and are not regenerable.  
 Remove the frontal panels for filters replacement.

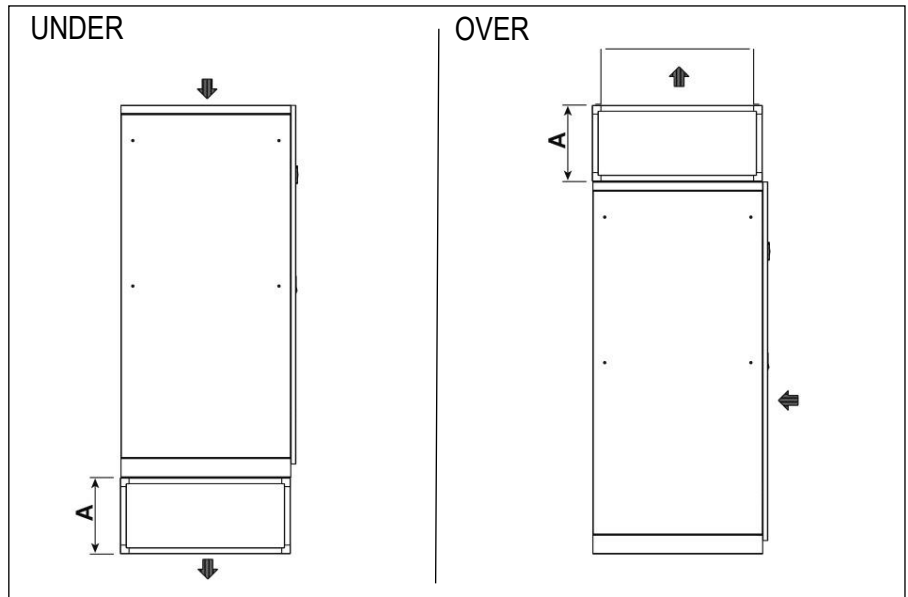

## PRESSURE DROPS – i-NEXT DW

MODEL		012 M1 S	018 M1 S	022 M1 S	030 M1 S	047 M1 S
<b>SIZE</b>		<b>E1</b>	<b>E2</b>	<b>E3</b>	<b>E4L</b>	<b>E5L</b>
A	mm	490	490	490	510	510
Weight (1)	kg	26	27	30	55	60
<b>PRESSURE DROPS (2)</b>						
Filters M6	Pa	58	113	64	45	81
Filters F7	Pa	72	115	79	55	99
Filters F9	Pa	86	138	97	67	121

MODEL		042 M2 D	068 M2 D	094 M2 D	120 M4 D (*)	150 M4 D (*)
<b>SIZE</b>		<b>E5L</b>	<b>E7L</b>	<b>E8L</b>	<b>E9L</b>	<b>E9L</b>
A	mm	510	510	510	510	510
Weight (1)	kg	60	90	100	110	110
<b>PRESSURE DROPS (2)</b>						
Filters M6	Pa	81	86	116	172	172
Filters F7	Pa	99	105	118	210	210
Filters F9	Pa	121	128	144	255	255

1. Add this value to the total unit weight
  2. Data referred to the nominal air flow and clean filters. Value to be subtracted from the maximum external static pressure of the unit.
- (\*) Only UNDER version

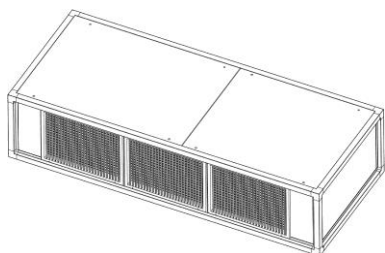

## PLENUM ON AIR DELIVERY WITH FRONTAL GRILLE

The plenum allows the frontal air distribution directly into the room.

The plenum is supplied with air distribution grille with double row adjustable grilles on front side.

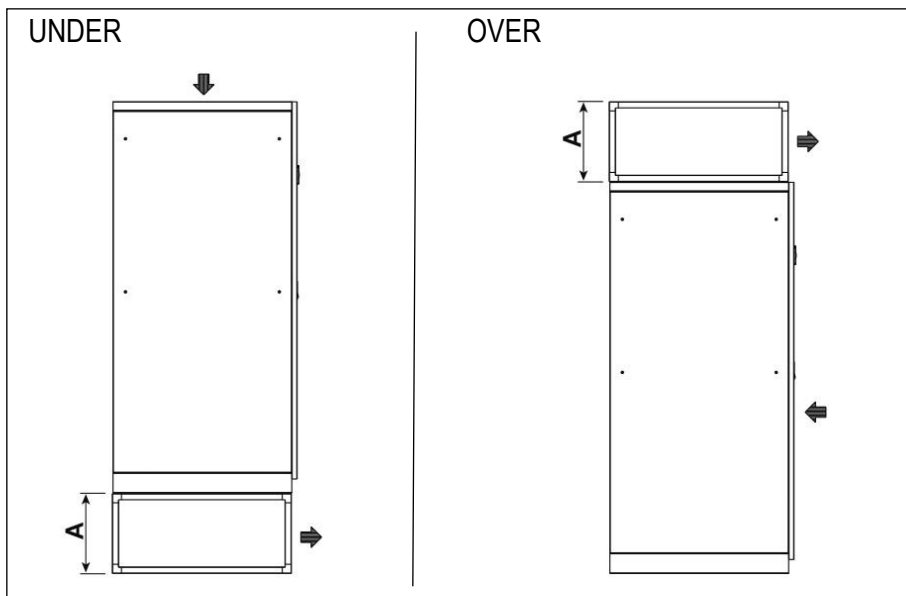

SIZE		E1	E2	E3	E4L	E5L	E7L	E8L	E9L (*)
A	mm	490	490	490	510	510	510	510	510
Weight (1)	kg	23	26	28	50	55	90	110	130

1. Add this value to the total unit weight

(\*) Only UNDER version

## PLENUM ON AIR DELIVERY WITH FRONTAL GRILLE REACTION TO FIRE - EUROCLASS A1

SIZE		E1	E2	E3	E4L	E5L	E7L	E8L	E9L (*)
A	mm	490	490	490	510	510	510	510	510
Weight (1)	kg	29	32	36	63	70	108	130	152

1. Add this value to the total unit weight

(\*) Only UNDER version

## PLENUM ON AIR DELIVERY WITH FRONTAL AND LATERAL GRILLES

The plenum allows the air distribution directly into the room.

The plenum is supplied with air distribution grilles with double row adjustable grilles on front and lateral side.

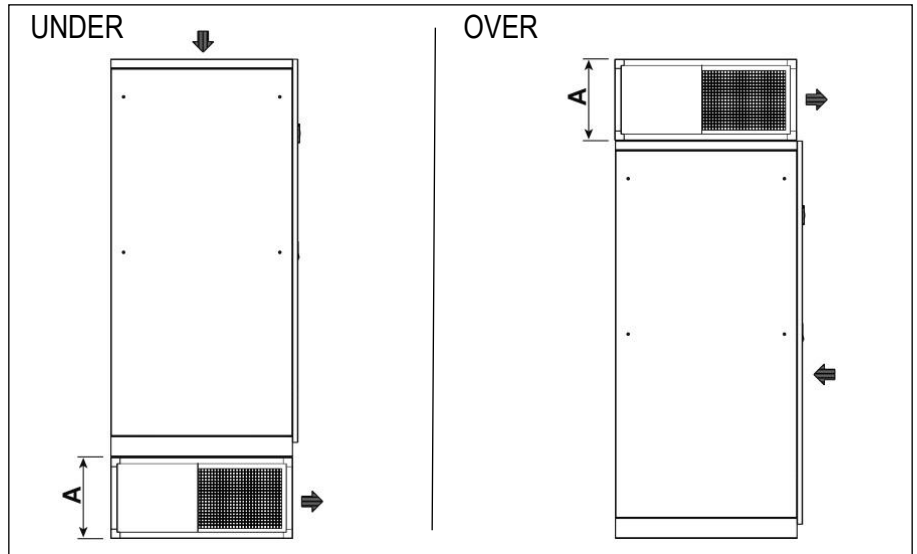
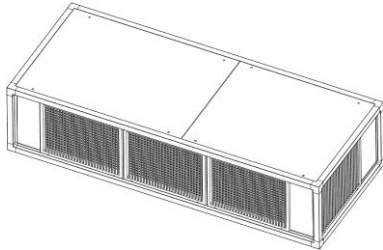

SIZE		E1	E2	E3	E4L	E5L	E7L	E8L	E9L (*)
A	mm	490	490	490	510	510	510	510	510
Weight (1)	kg	21	23	30	50	55	90	100	120

1. Add this value to the total unit weight  
 (\*) Only UNDER version

## PLENUM ON AIR DELIVERY WITH FRONTAL AND LATERAL GRILLES REACTION TO FIRE – EUROCLASS A1

SIZE		E1	E2	E3	E4L	E5L	E7L	E8L	E9L (*)
A	mm	490	490	490	510	510	510	510	510
Weight (1)	kg	25	28	37	61	68	106	118	140

1. Add this value to the total unit weight  
 (\*) Only UNDER version

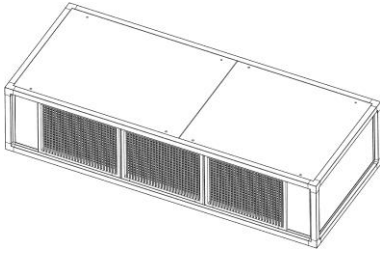

## PLENUM ON AIR DELIVERY WITH FRONTAL GRILLE AND NOISE ABSORPTION PARTITIONS

The optional is not available for Under version.

The plenum allows the frontal air distribution directly into the room and a noise reduction of the air delivery.

The plenum is supplied with air distribution grille with double row adjustable grilles on front side and noise absorption partitions,

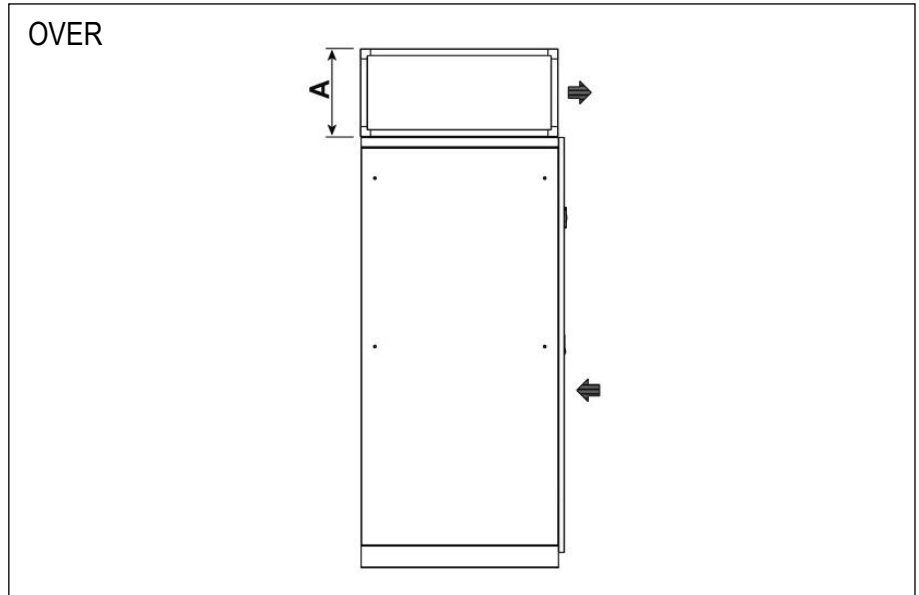

### i-NEXT DW

MODEL		012 M1 S	018 M1 S	022 M1 S	030 M1 S	047 M1 S
<b>SIZE</b>		<b>E1</b>	<b>E2</b>	<b>E3</b>	<b>E4L</b>	<b>E5L</b>
A	mm	490	490	490	510	510
Weight (1)	kg	30	30	37	72	77
<b>SOUND LEVEL ISO 3744 (2)</b>						
On air delivery, Over	dB(A)	60,0	62,1	61,2	65,9	76,4
On air intake, Over (3)	dB(A)	53,4	48,7	48,9	52,2	63,3
Irradiated, Over (4)	dB(A)	46,1	43,1	42,4	47,1	59,2
<b>ADDITIONAL PRESSURE DROPS (5)</b>	Pa	52	83	50	52	84
<b>AIR FLOW</b>	m <sup>3</sup> /h	2700	4100	5100	7500	12000

MODEL		042 M2 D	068 M2 D	094 M2 D
<b>SIZE</b>		<b>E5L</b>	<b>E7L</b>	<b>E8L</b>
A	mm	510	510	510
Weight (1)	kg	77	110	110
<b>SOUND LEVEL ISO 3744 (2)</b>				
On air delivery, Over	dB(A)	76,4	72,5	77,3
On air intake, Over (3)	dB(A)	63,3	59,6	64,4
Irradiated, Over (4)	dB(A)	59,2	55,3	60,1
<b>ADDITIONAL PRESSURE DROPS (5)</b>	Pa	84	102	120
<b>AIR FLOW</b>	m <sup>3</sup> /h	12000	17500	22000

1. Add this value to the total unit weight
2. Noise pressure level at 1 meter in free field – ISO 3744
3. Air intake from the front
4. Air intake from the bottom
5. Value to be subtracted from the nominal external static pressure of the unit

## OPTIONAL ACCESSORIES – DIRECT FREE-COOLING PLENUM

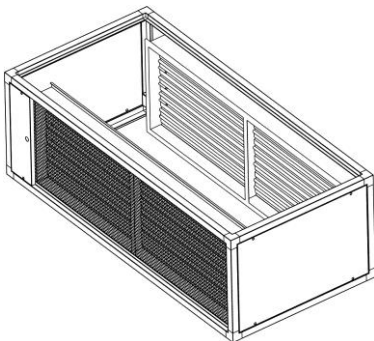
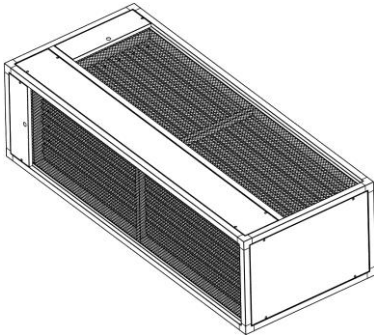

The plenums have same technical characteristics and base dimensions of the machine cabinet. The optional allow to obtain free-cooling by direct ambient air intake into the room. The dampers are proportionally managed by the microprocessor control, that regulates the quantity of the ambient air to put in the room according to the set-point.

### COMPONENTS

- Frame in aluminium extrusion, painted with epoxy powders. Colour RAL 9005;
- Panels in galvanized steel sheet with protective surfaces treatment in compliance with UNI ISO 9227/ASTMB117 and ISO 7253, and painted with epoxy powders. Colour RAL 9005;
- Panels insulated with polyurethane foam and seals to ensure air tight.
- Panels fixed with screws.
- Removable panels.
- Opposed blade dampers in galvanized steel sheet and safety grille for ambient air and room air suction.
- Actuator for each damper.
- Terminals for electric connection to the unit.
- Combined Temperature / Humidity sensor on machine air suction. The sensor must be moved outside the air conditioners for a proper read of the room temperature value.
- Temperature sensor for outdoor air. The sensor must be installed in the outdoor air suction duct or anyway protected against atmospheric agent.
- Free contact for free-cooling operating status monitoring.
- Set of fixing elements to fasten the plenum to the unit.

For a correct installation use a gasket between the plenum and the unit.

### WARNING

**IT IS COMPULSORY TO INSTALL INTO THE ROOM AN APPROPRIATELY SIZED OVERPRESSURE DAMPER TO ALLOW THE ROOM AIR EXHAUSTION DURING FREE-COOLING WORKING MODE.**

### INSTALLATION EXAMPLE

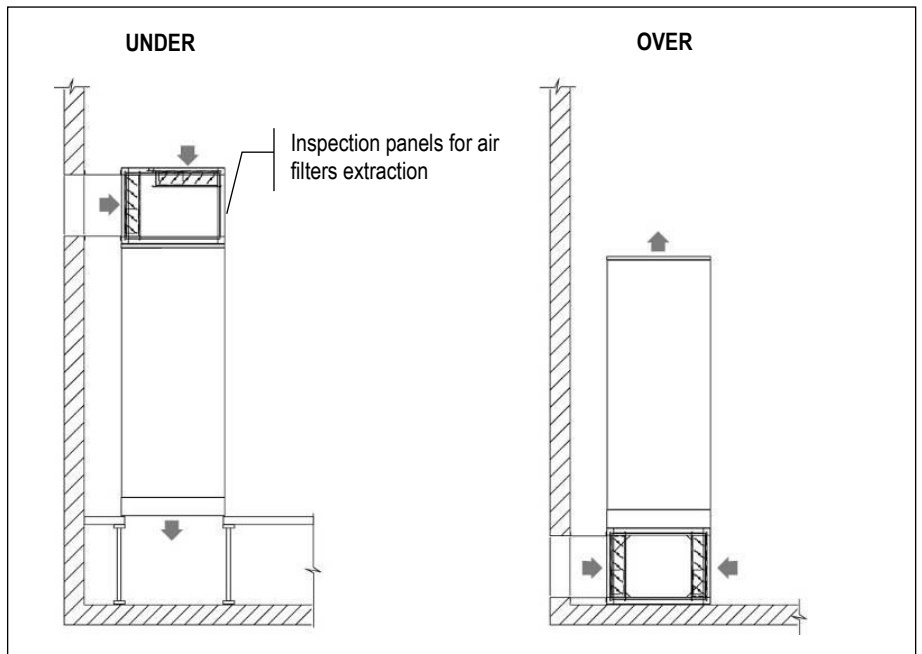

Ducting are at Customer care.  
We suggest you to install a rain-proof grille on ambient air intake.

## OVER VERSION

### Size E1 / E2 / E3

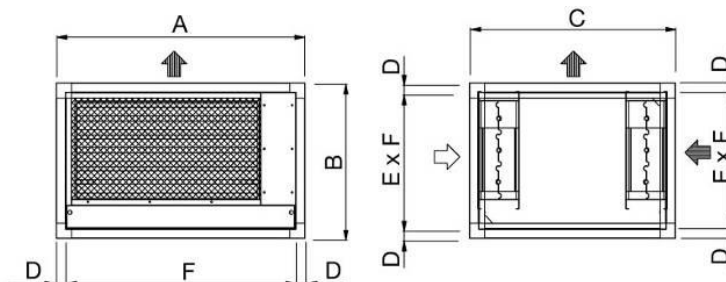

### Size E4L / E5L

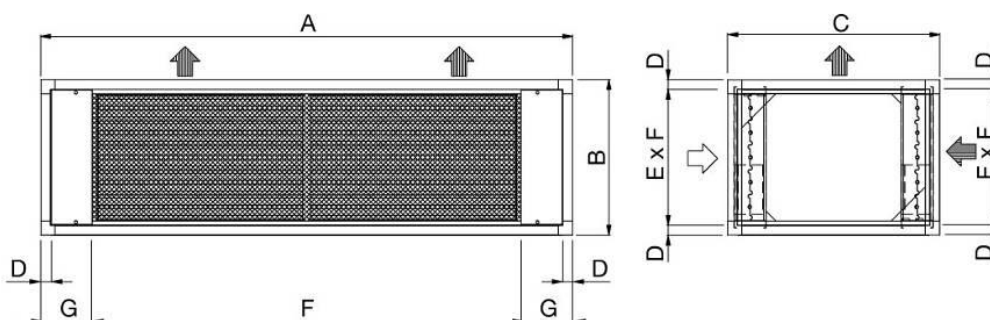

### Size E6L / E7L / E8L

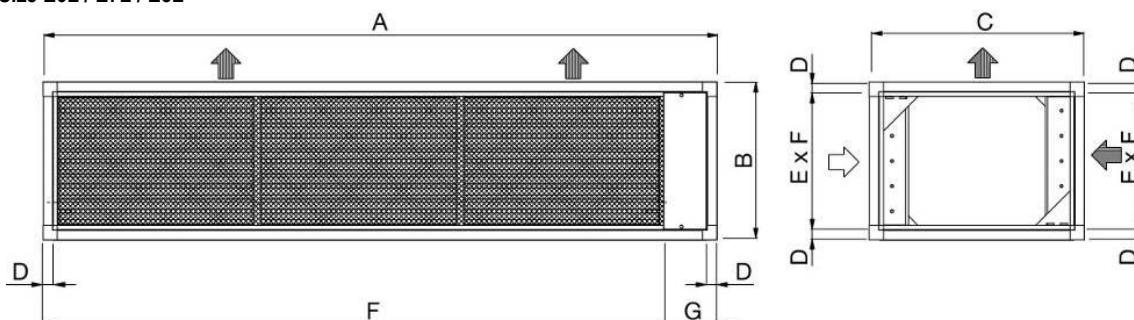

Size		E1	E2	E3	E4L	E5L	E7L	E8L	E9L (*)
A	mm	650	785	1085	1630	1955	2499	2899	--
B	mm	490	490	490	630	630	630	630	--
C	mm	650	650	750	905	905	905	905	--
D	mm	30	30	30	40	40	40	40	--
E	mm	430	430	430	550	550	550	550	--
F	mm	590	725	1025	1335	1335	1965	2220	--
G	mm	--	--	--	147,5	472,5	534	679	--
Weight (1)	kg	24	27	35	147,5	147,5	--	--	--

1. Add this value to the total unit weight

UNDER VERSION

**SIZE E1 / E2 / E3**

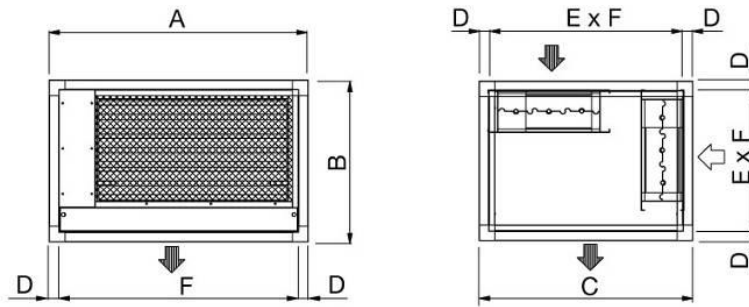

**SIZE E4L / E5L**

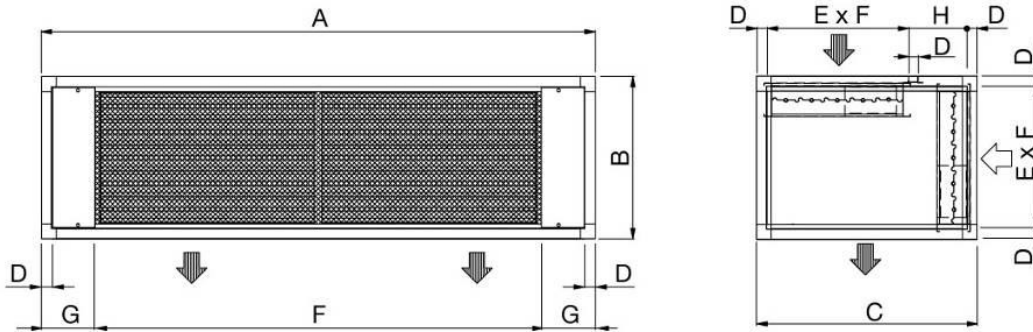

**SIZE E6L / E7L / E8L / E9L**

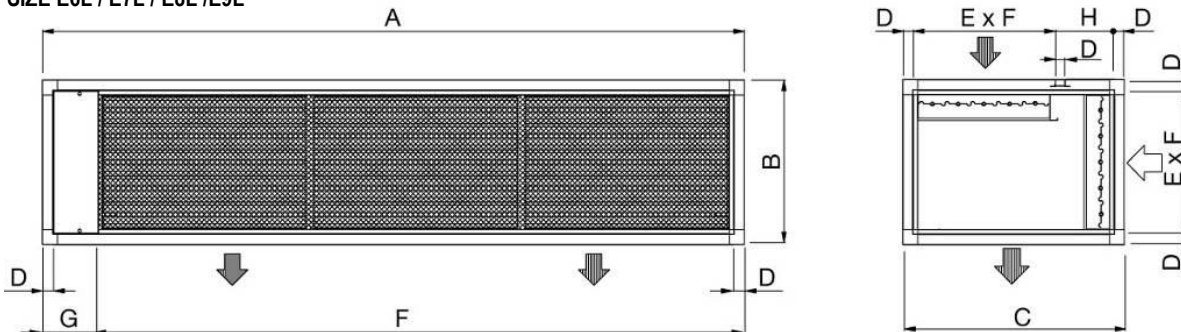

Size		E1	E2	E3	E4L	E5L	E7L	E8L	E9L
A	mm	650	785	1085	1630	1955	2499	2899	3299
B	mm	490	490	490	630	630	630	630	630
C	mm	650	650	750	905	905	905	905	905
D	mm	30	30	30	40	40	40	40	40
E	mm	430	430	430	550	550	550	550	550
F	mm	590	725	1025	1335	1335	1965	2220	2375
G	mm	--	--	--	147,5	472,5	534	679	924
H	mm	--	--	--	147,5	147,5	--	--	--
Weight (1)	kg	24	27	35	61	66	110	130	150

1. Add this value to the total unit weight



## OPTIONAL ACCESSORIES – BOTTOM PANEL FOR OVER VERSION

Available for OVER units.

With this accessory, it is possible a noise insulation of the machine base, when the machine is installed directly on particular floor as raised floor, wood floor etc.

The accessory includes:

- Panel in galvanized steel sheet.
- Noise insulation with special soundproof material.

The bottom panel is supplied assembled inside the unit base and does not modify the unit dimensions.

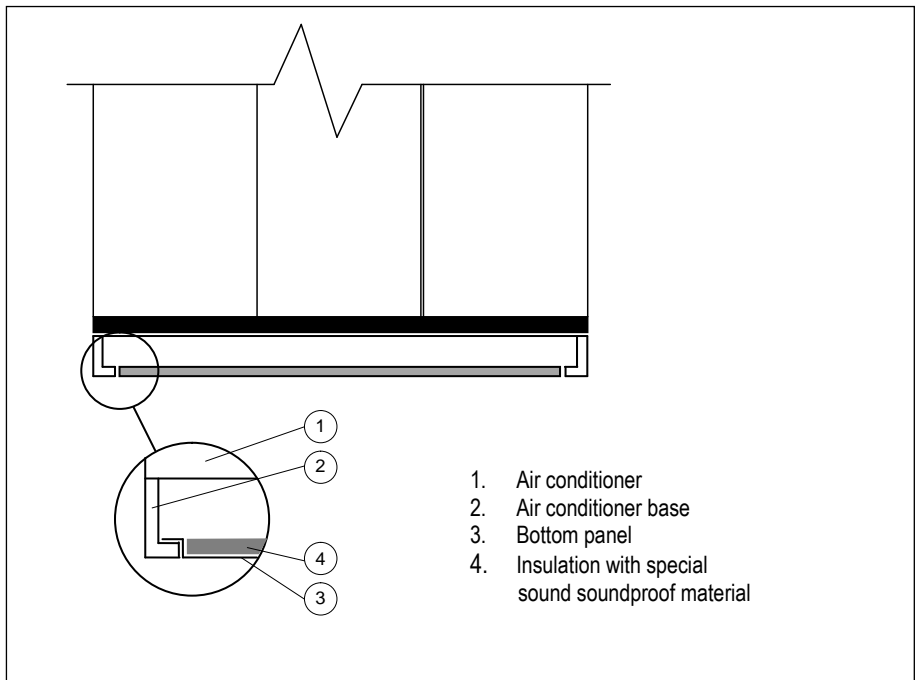

## OPTIONAL ACCESSORIES – KIPlink – Keyboard in your Pocket



**KIPlink** - Keyboard In Your Pocket - is the innovative user interface based on WiFi technology that allows one to operate on the unit directly from the smartphone or tablet. Using KIPlink, it is possible to turn the unit on and off, adjust the set-point, plot the main operating variables, monitor in detail the status of the refrigerant circuits, the compressors, the fans and display and reset the possible alarms.

Scan the QR code on the electrical board of the unit to have access to the unit control through web browser web or App. The access is possible within the local WiFi network.

KIPlink hardware:

- Wi-Fi antenna in the electrical board;
- ON/OFF button with power LED and Unit status LED. Provided when the unit is equipped with KIPlink and without 6-keys keyboard (optional).

KIPlink allows;

- Easy and enhanced unit management
- Real-Time graphs and key trends
- Different information for each kind of user

## OPTIONAL ACCESSORIES – RC CLOUD PLATFORM: WEB SERVICES BASED ON CLOUD TECHNOLOGY FOR REMOTE MONITORING AND MANAGEMENT OF AIR CONDITIONING PLANTS.



Log-in to the web site  
<http://rccloudplatform.rcgroup.it>  
automatic language recognition

**RC Cloud Platform** is an ecosystem of web services for remote monitoring and management of air conditioning plants; specifically designed for mobile usage on tablets and smartphones, it allows to access plant data everywhere on the go so saving time, money and delivering a higher service level to the customer.

### TECHNOLOGY

Based on cloud technology it allows, through machines data telemetry, to monitor and control units on the field, process data and perform proactive maintenance.

The hardware heart of the system is the RC Cloud box that can collect plant data (up to 31 devices and up to 1000 registers).

Connectivity between monitored devices and RC Cloud box may be wired in Ethernet, RS485, RS232 and must be in MODBUS protocol.

RC Cloud Platform then send these data to dedicated server in cloud in through the mobile (GPRS or 3G) network or ADSL.

RC considers with great attention the security of customer information, so every communication channel may be encrypted in VPN, guaranteeing privacy and typical security policies commitment.

### USER SIDE

RC Cloud Platform is designed for mobile communication. So, the user just need a tablet or a smartphone to access the RC Cloud Platform and check his plant.

RC Cloud Platform App is available both on Android and iOS operating systems so the environment may be accessed directly from them beyond company site and platform site (<http://rccloudplatform.rcgroup.it>). Access through pc is available too.

### FUNCTIONS

#### Telemetry & Data Export

Data polling and history of all data (1 year).  
Export diagram and table (csv). **Your data always on the go.**

#### Multi Device

Many type of devices can be connected to the same box (chillers, close control, energy meters, flow meters, pumps,...).  
Only a request: MODBUS protocol. Electrical connection in Ethernet, RS 485 or RS 232.

#### Multi Language

English native, RC Cloud Platform language pack is available for the main markets.

#### Virtual Display

Monitoring and control (on/off, alerts reset, main parameters change) as being beside the unit, in an augmented reality way.

Designed for Mobile.

**Same as standing in front of the unit, when in your office or in any other place.**

#### Internet Connectivity

ETHERNET + GPRS + 3G connection capability on Public and Virtual Private Network (VPN).  
Your security and privacy are a top priority.

#### Alerts Warning through:

- Push notification
- e-mail
- Voice calls
- SMS

#### Processing of specialized plant KPI to get:

- Energy performance (gross instant EER)
- Components Failure Forecast (coming soon)
- Unit diagnosis
- Components Failure Forecast (coming soon)
- Unit diagnosis



**MACHINE DRAWINGS**

Dimensions in mm – i-NEXT DW Under E1

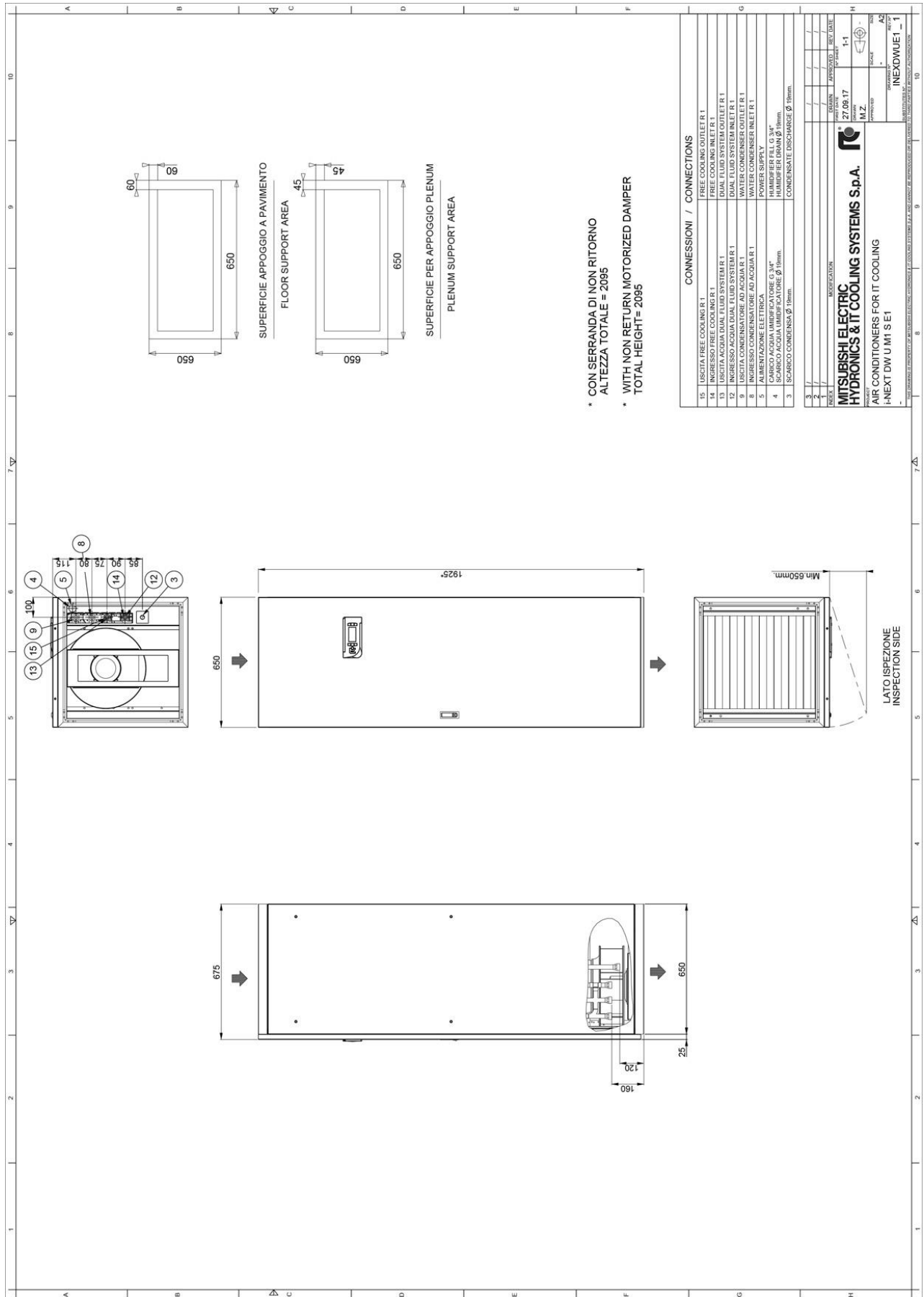

\* CON SERRANDA DI NON RITORNO  
 ALTEZZA TOTALE = 2095

\* WITH NON RETURN MOTORIZED DAMPER  
 TOTAL HEIGHT= 2095



## MACHINE DRAWINGS - Dimensions in mm – i-NEXT DW Under E2

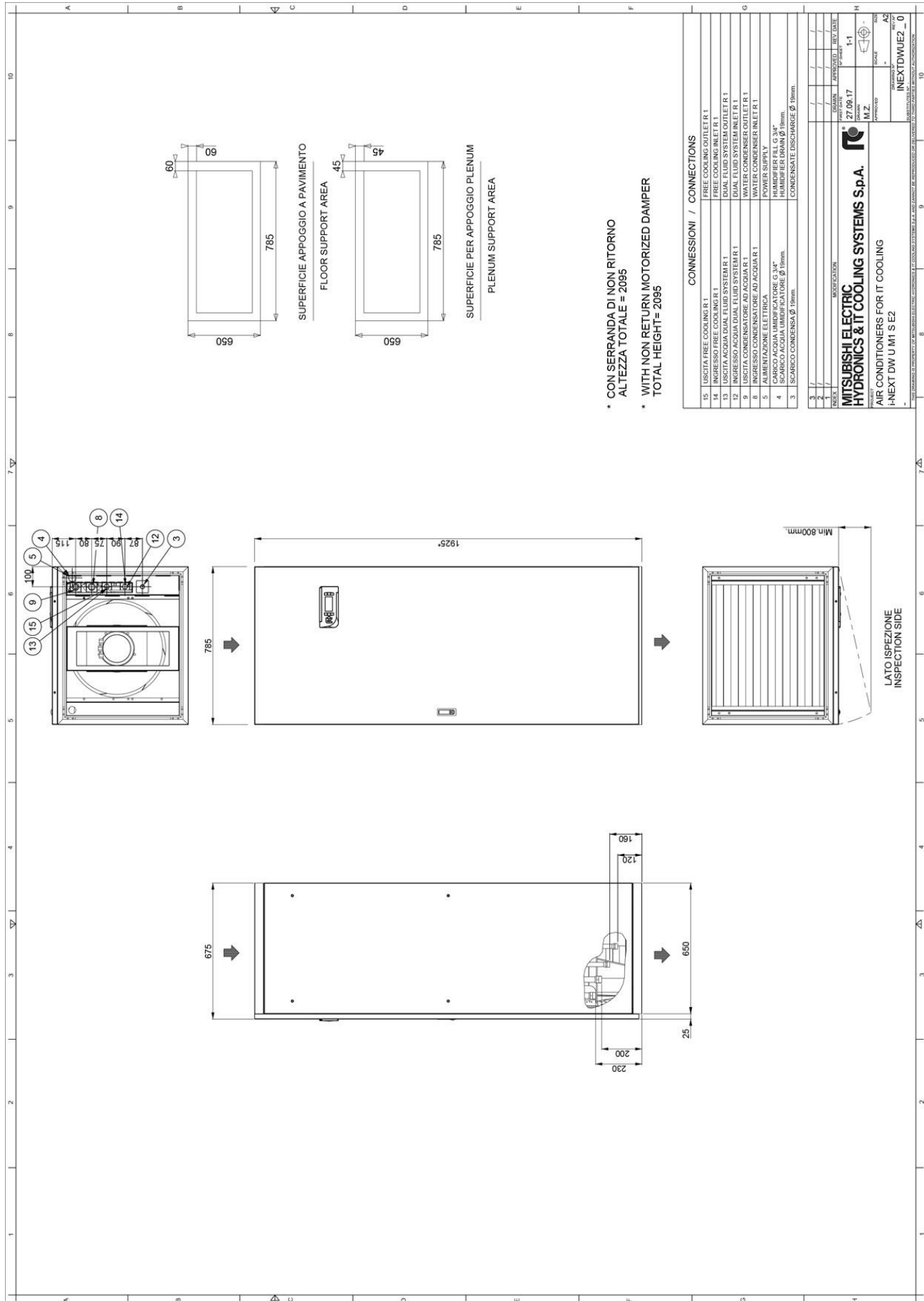

## MACHINE DRAWINGS - Dimensions in mm - i-NEXT DW Under E3

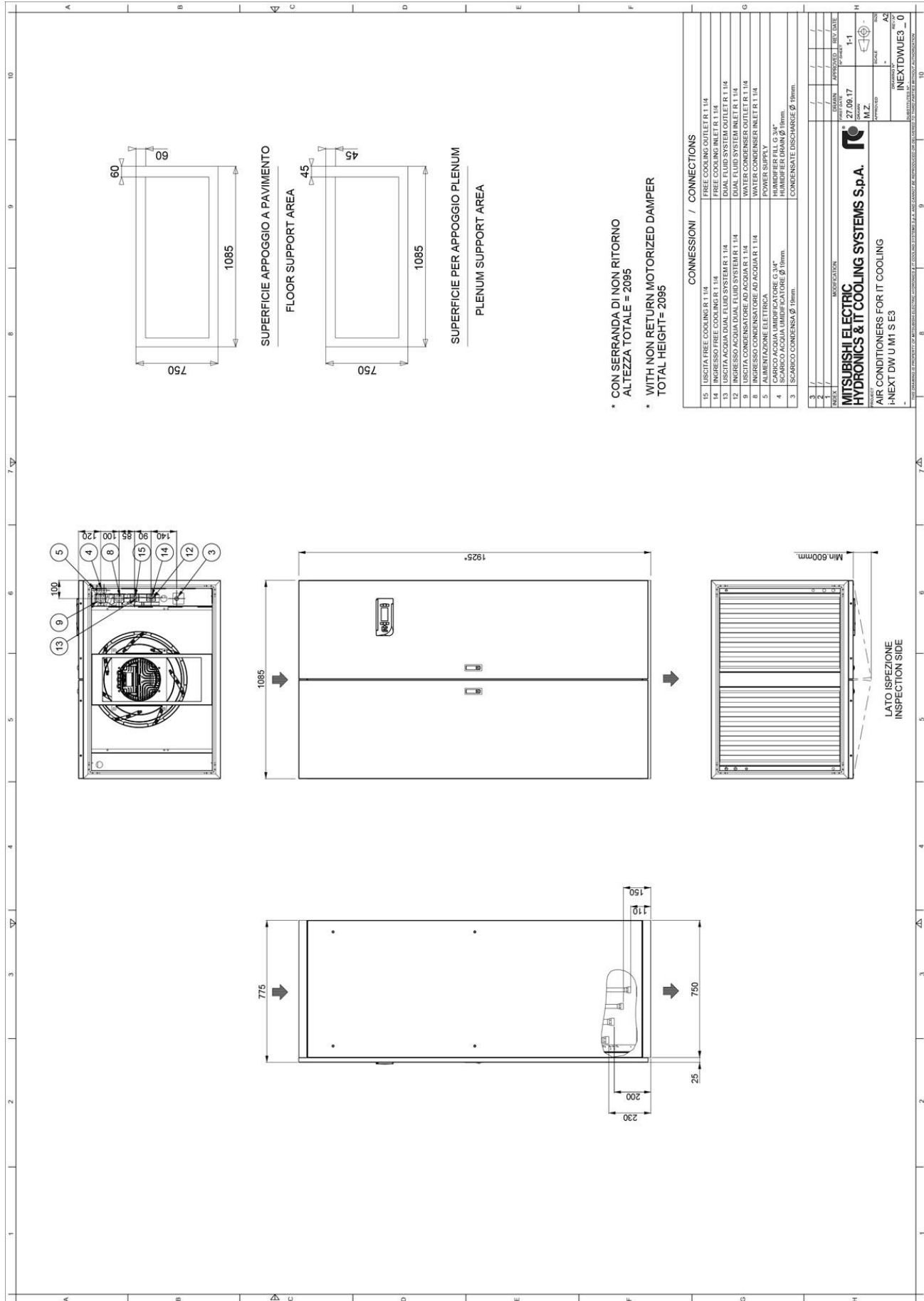



**MACHINE DRAWINGS - Dimensions in mm – i-NEXT DW Under E5L**

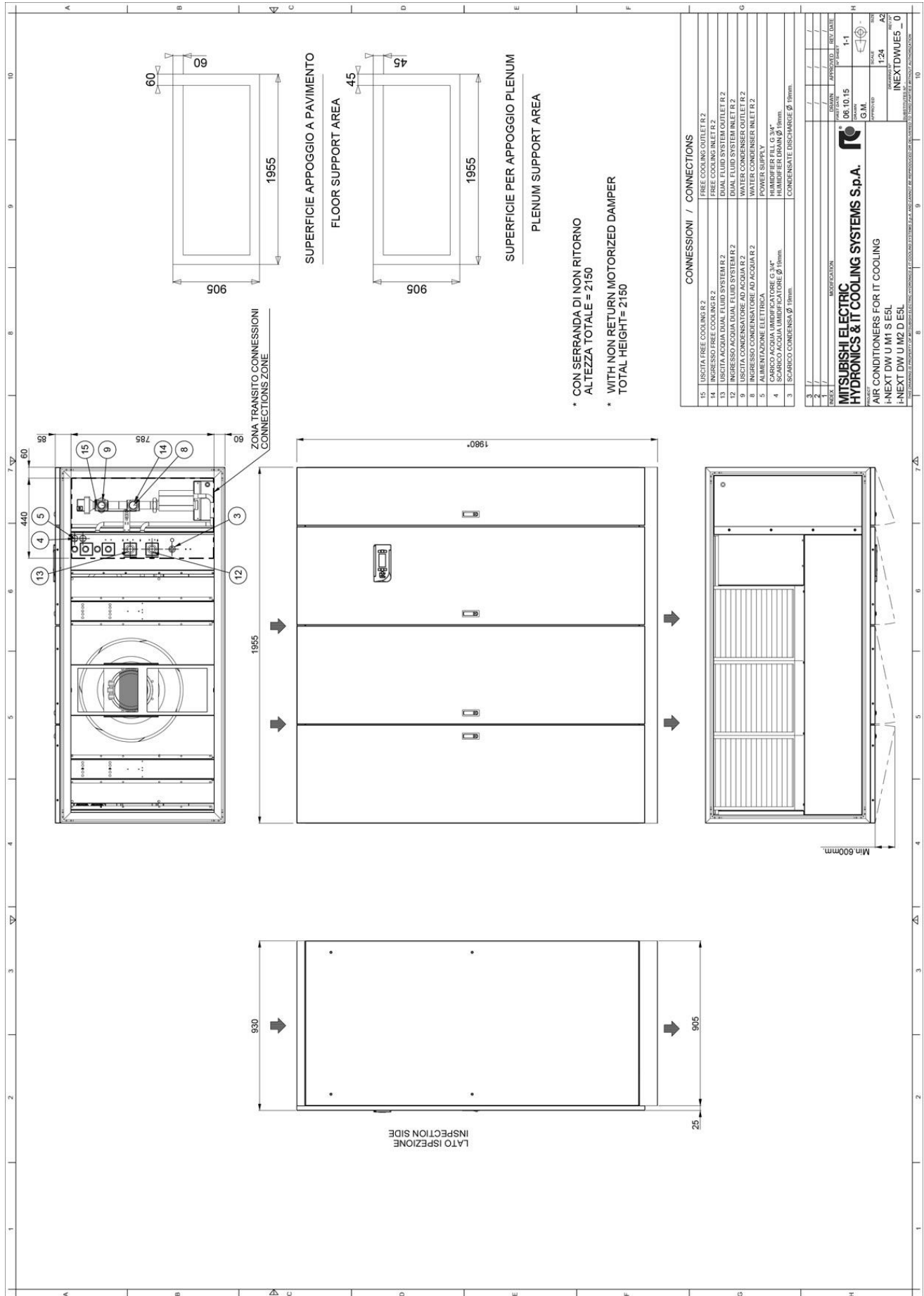

## MACHINE DRAWINGS - Dimensions in mm – i-NEXT DW Under E7L

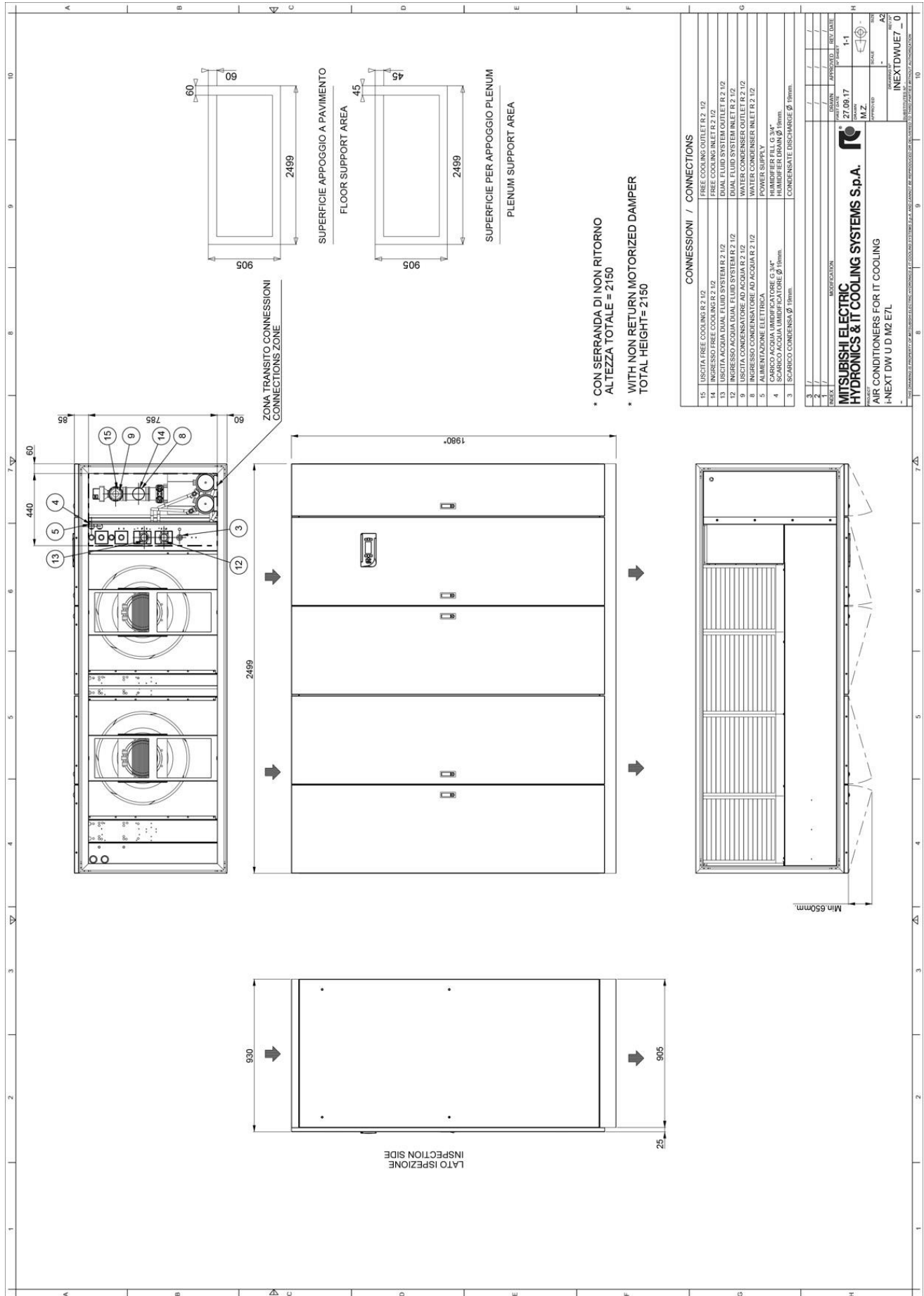





## MACHINE DRAWINGS - Dimensions in mm – i-NEXT DW Under E9L

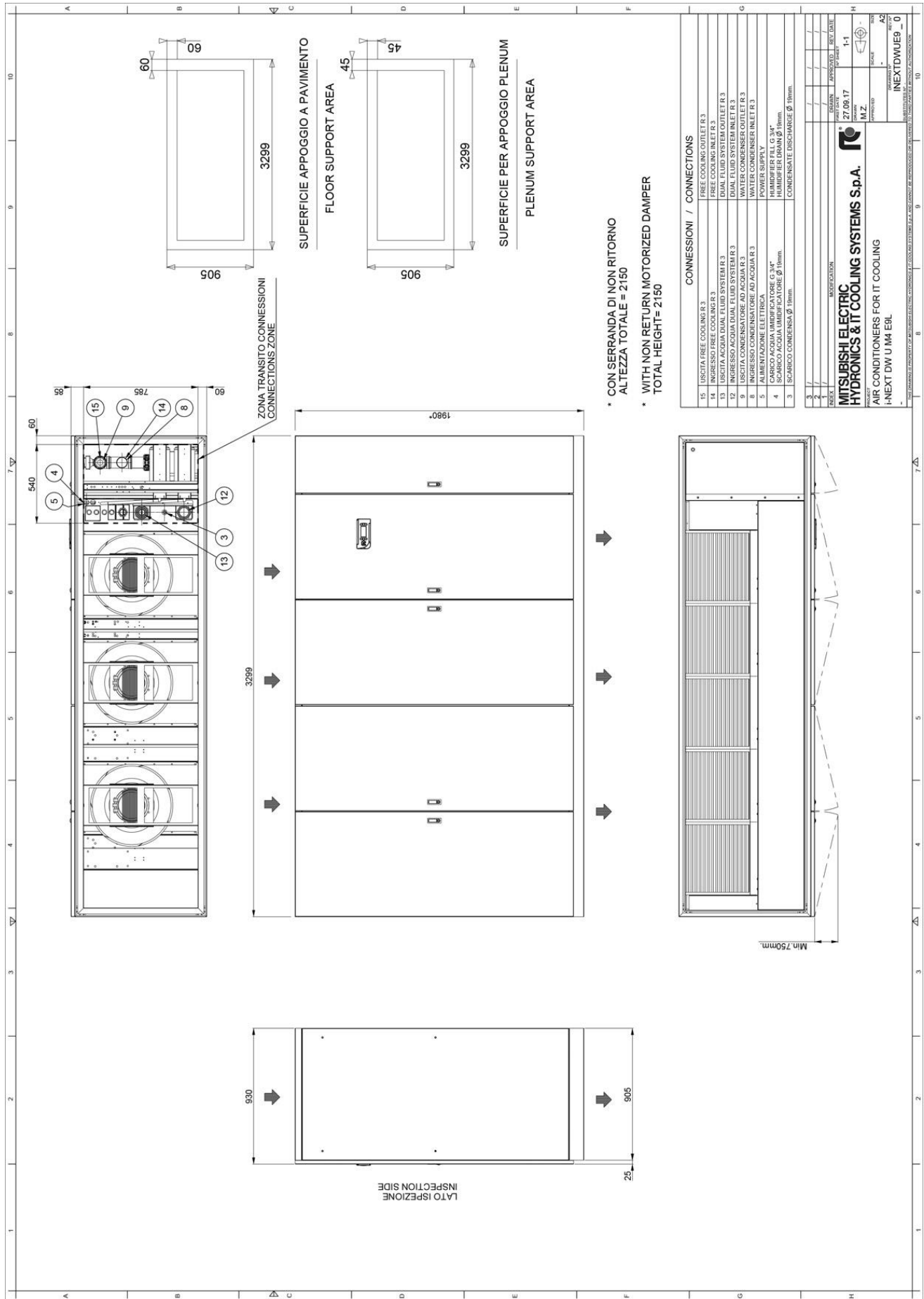



## MACHINE DRAWINGS - Dimensions in mm – i-NEXT DW Over E2

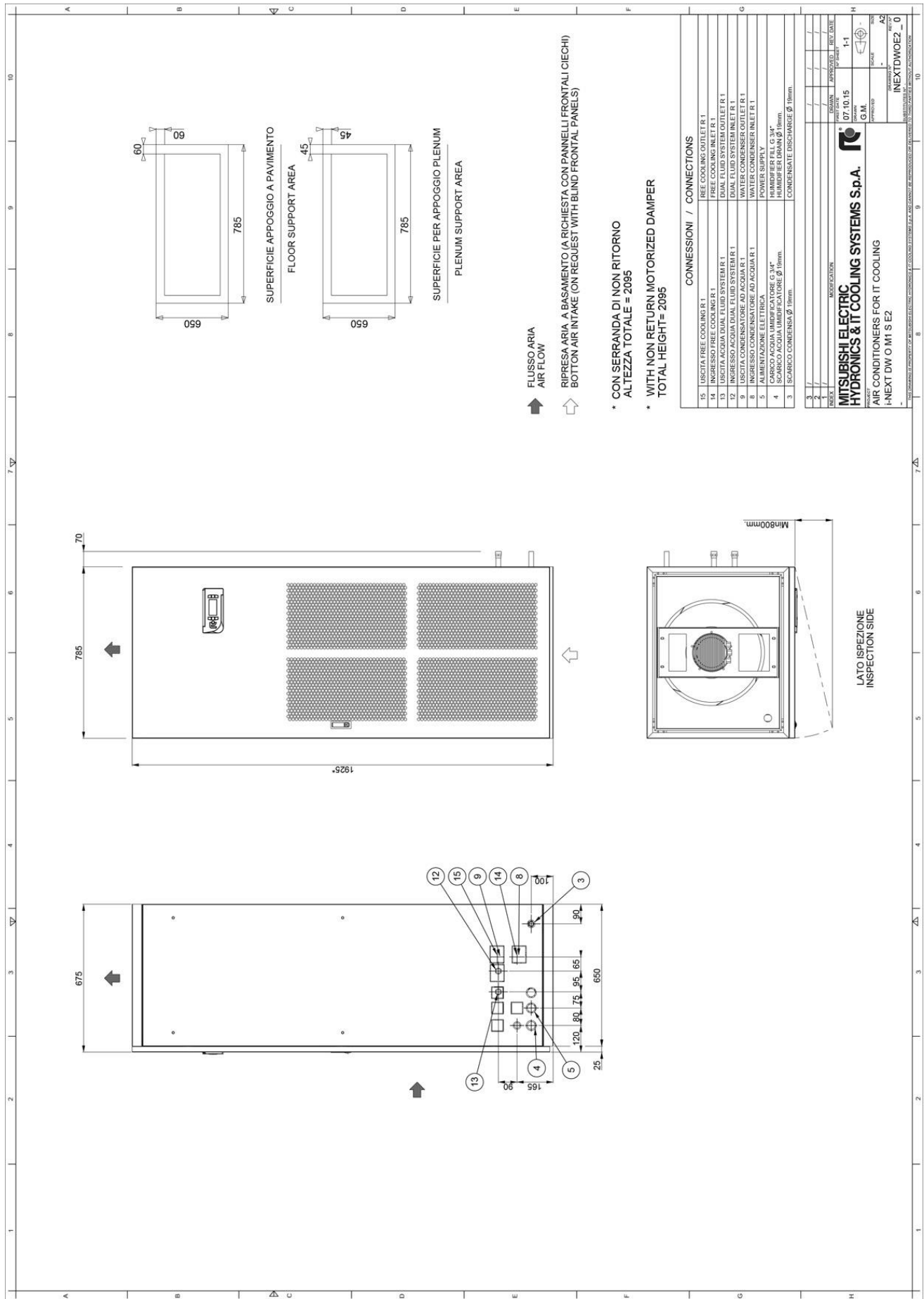

## MACHINE DRAWINGS - Dimensions in mm – i-NEXT DW Over E3

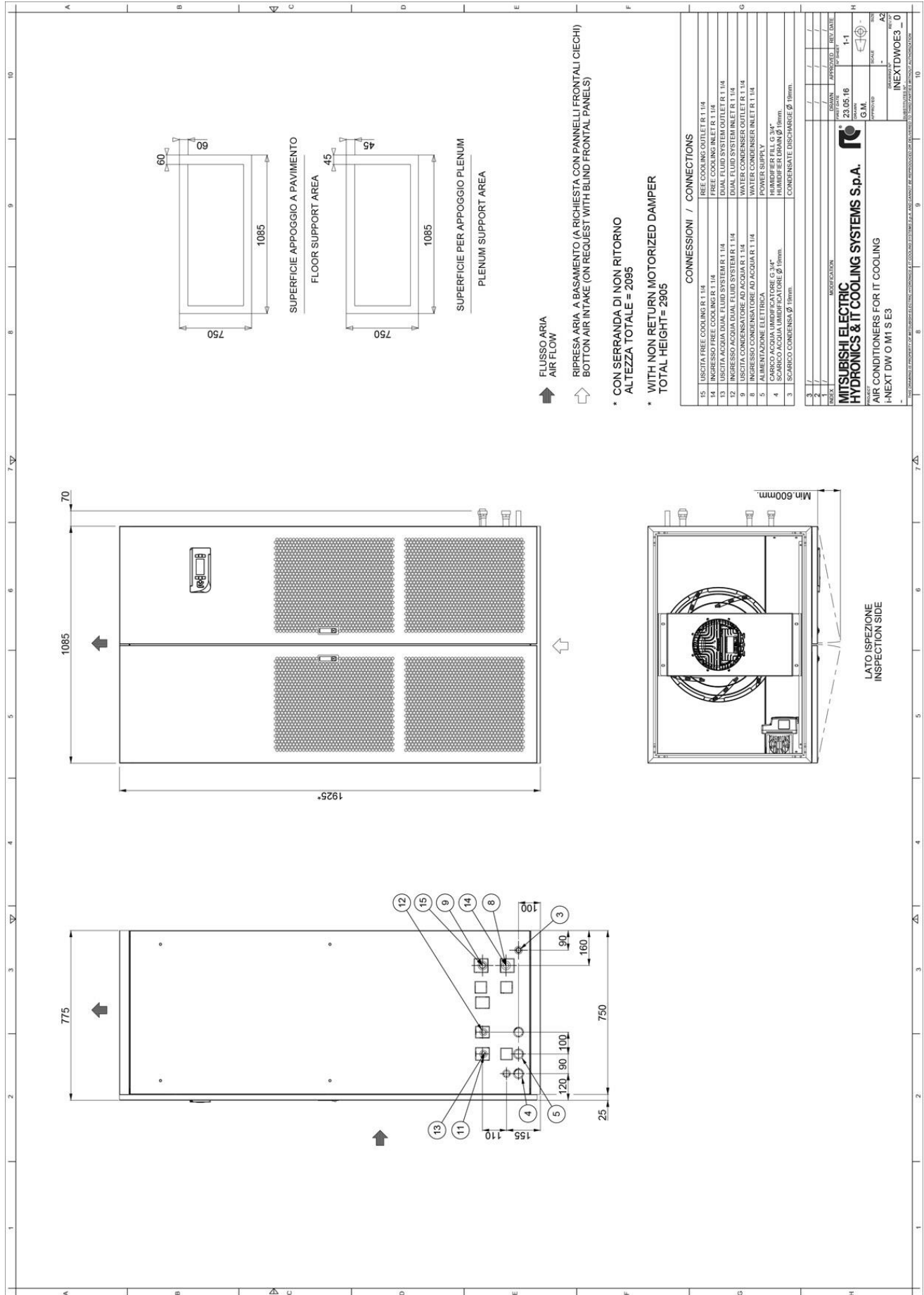



## MACHINE DRAWINGS - Dimensions in mm – i-NEXT DW Over E5L

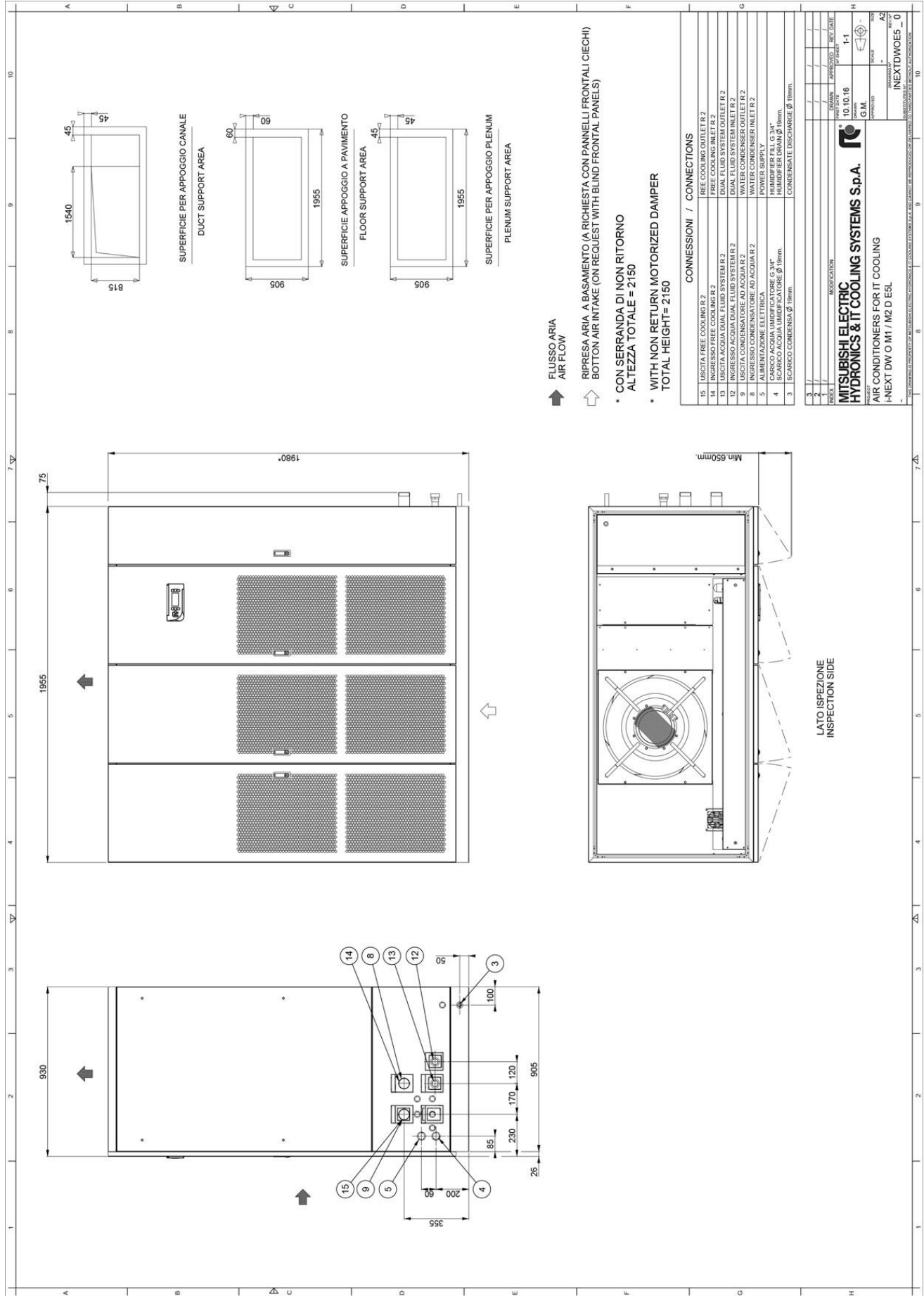

## MACHINE DRAWINGS - Dimensions in mm – i-NEXT DW Over E7L

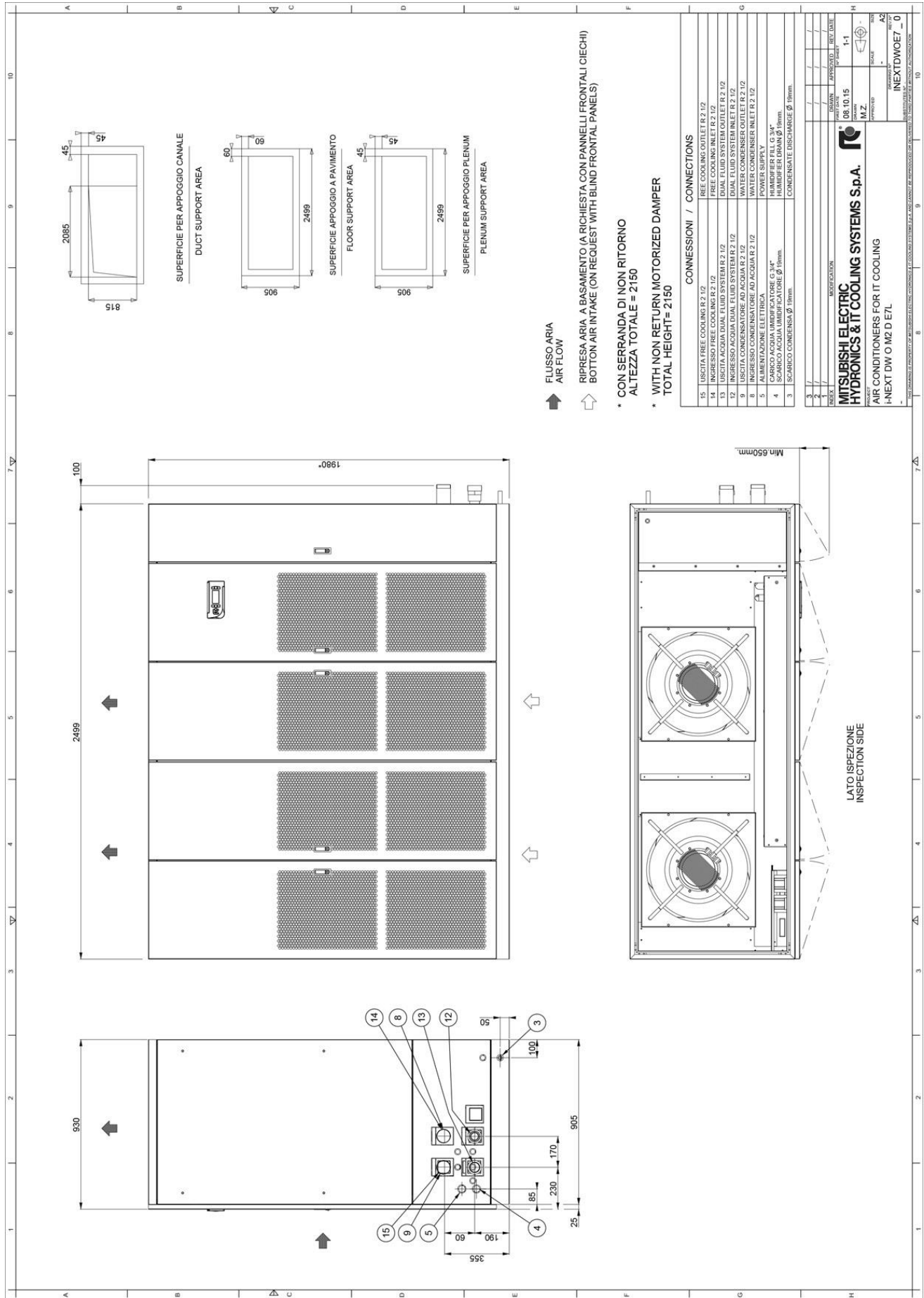



## MACHINE DRAWINGS - Dimensions in mm – i-NEXT DW Over E8L

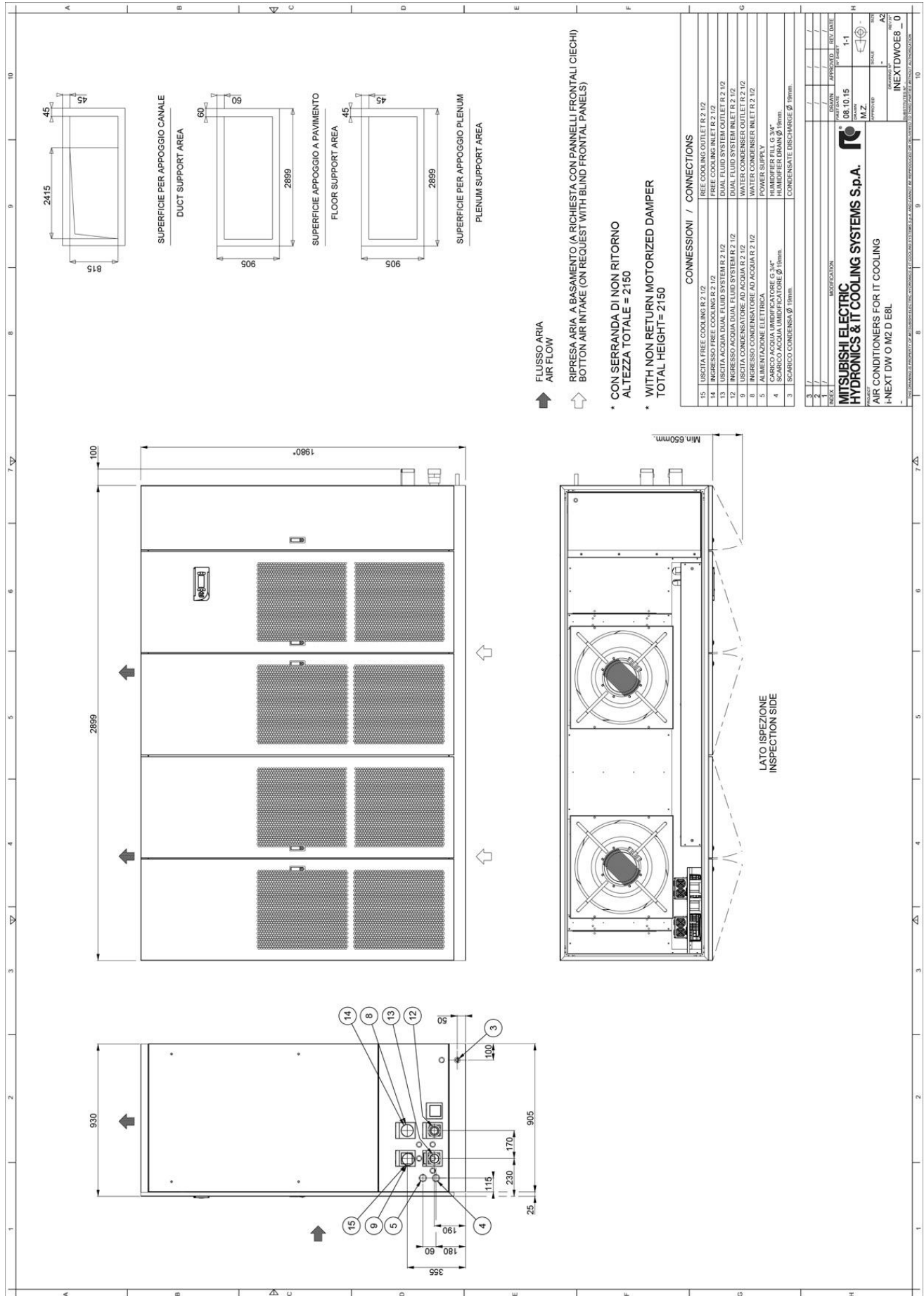

## HOLE IN THE RAISED FLOOR FOR DOWNFLOW VERSION

### HOLE IN THE RAISED FLOOR WITHOUT FLOOR STAND

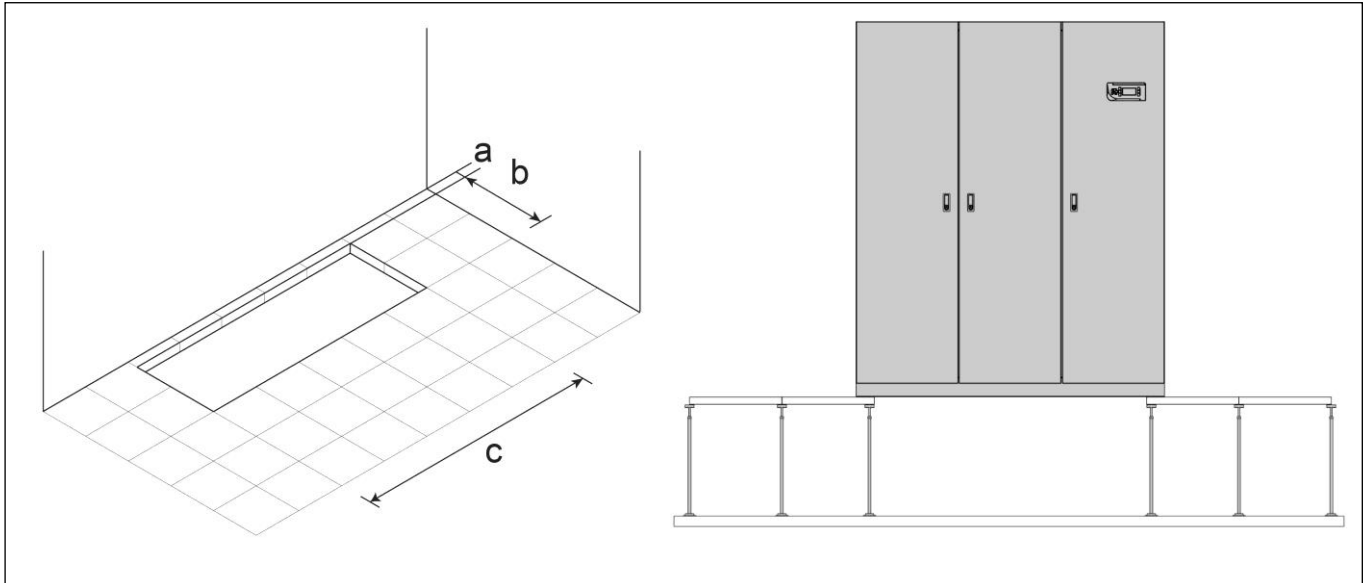

Foresee a hole in the floor with the following dimensions:

		E1	E2	E3	E4L	E5L	E7L	E8L	E9L
a	mm	95	95	95	110	110	110	110	110
b	mm	560	560	660	785	785	785	785	785
c	mm	560	695	995	1510	1835	2400	2780	3180

### HOLE IN THE RAISED FLOOR WITH FLOOR STAND (OPTION)

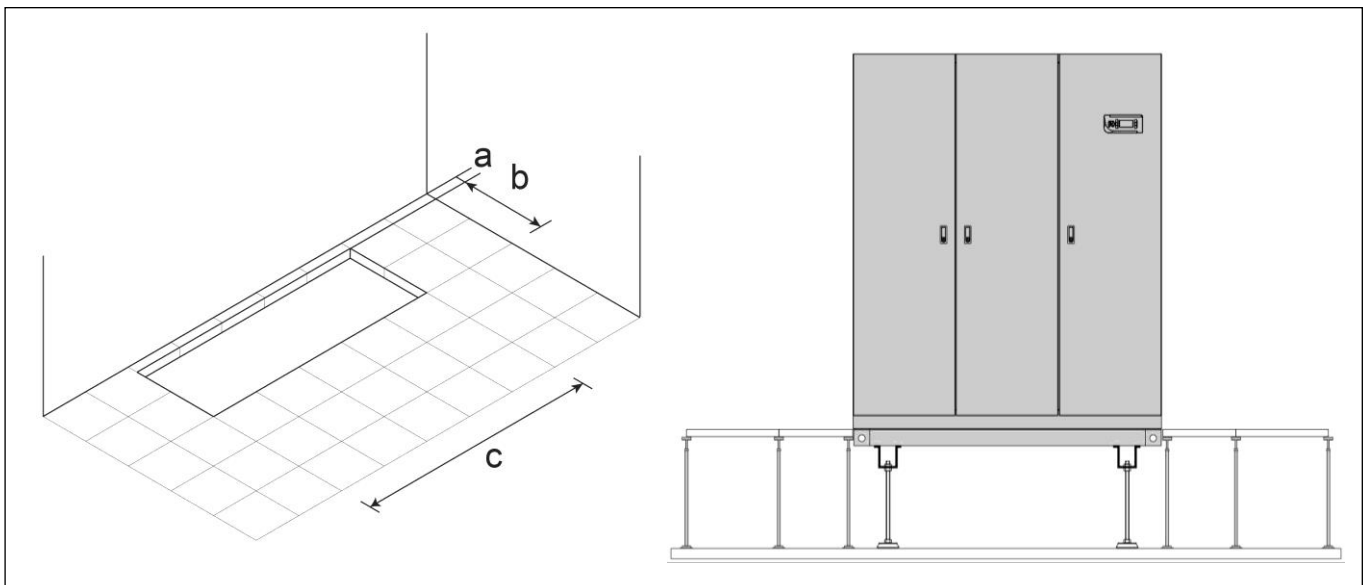

Foresee a hole in the floor with the following dimensions:

		E1	E2	E3	E4L	E5L	E7L	E8L	E9L
a	mm	50	50	50	50	50	50	50	50
b	mm	670	670	770	925	925	925	925	925
c	mm	670	805	1105	1650	1975	2520	2920	3320

## EXAMPLE FOR MACHINES NOISE EMISSION CALCULATION

### i-NEXT DW UNDER WITH DUCT ON AIR INTAKE

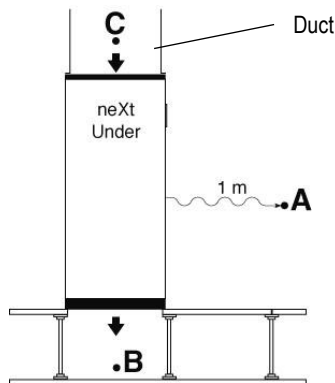

Lp A = Front side Under catalogue value

Lp B = Air delivery Under catalogue value

Lp C = Air intake Under catalogue value

The points B and C do not influence the point A

### i-NEXT DW UNDER WITH PLENUM ON AIR DELIVERY

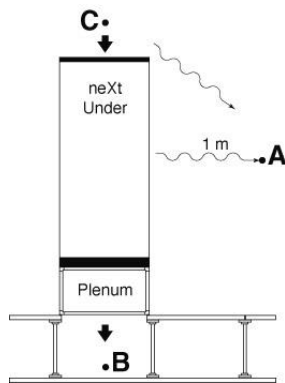

Lp A = Front side Under catalogue value

Lp B = Air delivery Under catalogue value – plenum noise reduction

Lp C = Air intake Under catalogue value

$$Lp A+C = 10 \log_{10} \left( 10^{\frac{LpA}{10}} + 10^{\frac{LpC}{10}} \right)$$

The point B do not influence the point A

### i-NEXT DW UNDER WITH PLENUM ON AIR INTAKE

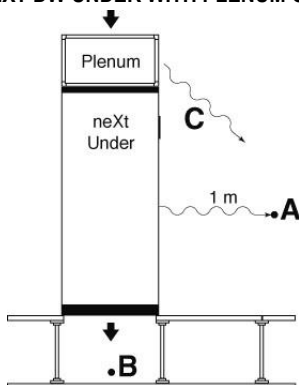

Lp A = Front side Under catalogue value

Lp B = Air delivery Under catalogue value

Lp C = Air intake Under catalogue value – plenum noise reduction

$$Lp A+C = 10 \log_{10} \left( 10^{\frac{LpA}{10}} + 10^{\frac{LpC}{10}} \right)$$

The point B do not influence the point A

### i-NEXT DW OVER WITH DUCT

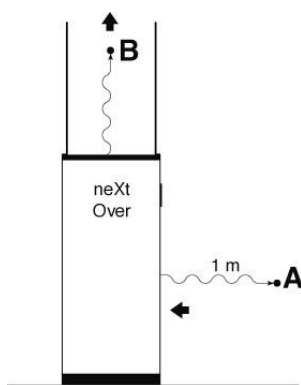

Lp A = Air intake Over catalogue value

Lp B = Air delivery Over catalogue value

The point B do not influence the point A

## EXAMPLE FOR MACHINES NOISE EMISSION CALCULATION

### i-NEXT DW OVER WITH PLENUM ON AIR DELIVERY

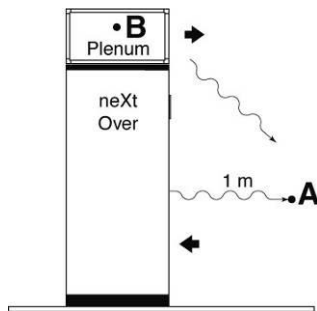

Lp A = Air intake Over catalogue value

Lp B = Air delivery Over catalogue value – plenum noise reduction

$$L_p A+B = 10 \log_{10} \left( 10^{\frac{L_p A}{10}} + 10^{\frac{L_p C}{10}} \right)$$

### i-NEXT DW OVER WITH DUCT AND PLENUM ON AIR DELIVERY

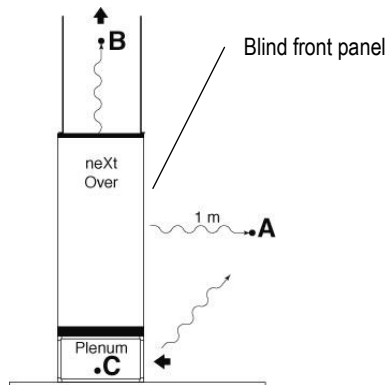

Lp A = Radiated Over catalogue value

Lp B = Air delivery Over catalogue value

Lp C = Lp A + 6dB(A) – plenum noise reduction

$$L_p A+C = 10 \log_{10} \left( 10^{\frac{L_p A}{10}} + 10^{\frac{L_p C}{10}} \right)$$

The point B do not influence the point A+C

### i-NEXT DW OVER WITH DUCT AND PLENUM ON AIR DELIVERY

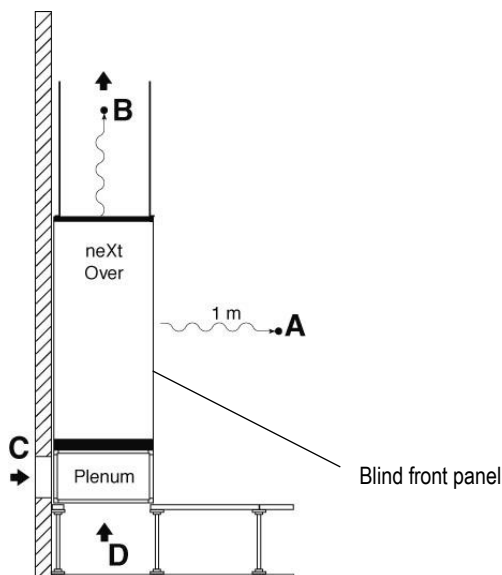

Lp A = Radiated Over catalogue value

Lp B = Air delivery Over catalogue value

Lp C = Lp D = Lp A + 6 dB(A) – plenum noise reduction

The points B, C and D do not influence the point A

### IMPORTANT

The declared noise levels are intended in free field conditions.

The noise pressure level of an installed unit is affected by the room acoustic characteristics.

Please consider an average noise increase of +4/+6 dB(A).

## VALVE PRESSURE DROP CALCULATION AS FUNCTION OF WATER FLOW RATE

Flow coefficient  $k_v$  defines the water flow (between 5°C and 40°C) expressed in m<sup>3</sup>/h that cross a valve with a pressure drop of 1bar (100kPa).

With this data is possible to calculate the localized pressure drop as function of the water flow rate.

$$\Delta P = (Q / k_v)^2$$

$\Delta P$  (bar) = localized pressure drop of valve;

$Q$  (m<sup>3</sup>/h) = water flow rate – it varies according to the desired operating condition;

$k_v$  (m<sup>3</sup>/h) = valve flow coefficient.

The formula allows to calculate the value of the localized pressure drop (in bar).

The pressure drops values showed on the documentation are supplied in kPa.

Is possible to change from one unit to another through the following conversion.

$$1 \text{ bar} = 100\text{kPa}$$

### CALCULATION EXAMPLE OF CONDENSING CONTROL VALVE PRESSURE DROP IN FUNCTION OF CONDENSER WATER FLOW RATE.

#### i-NEXT DW 068 M2 D E7L – Nom Cooling Capacity

Example at nominal conditions. Characteristics referred to entering air at 26°C-40%UR; water to the condenser 30-36°C

Condenser water flow rate: 14,8 m<sup>3</sup>/h

Condenser pressure drop 22 kPa

Valve flow coefficient  $k_v$ : 25,0 m<sup>3</sup>/h

Condensing control valve pressure drop:  $\Delta P = (Q / k_v)^2 = (14,8 / 25)^2 = 0,350 \text{ (bar)} * 100 \text{ (kPa / bar)} = 35,0 \text{ kPa}$

Pressure drop (condenser + valve) = 22 + 35,0 = 57,0 kPa

## AIR FILTERS REPLACEMENT FOR UNDER VERSION MACHINES SIZE E4L – E5L – E7L – E8L – E9L

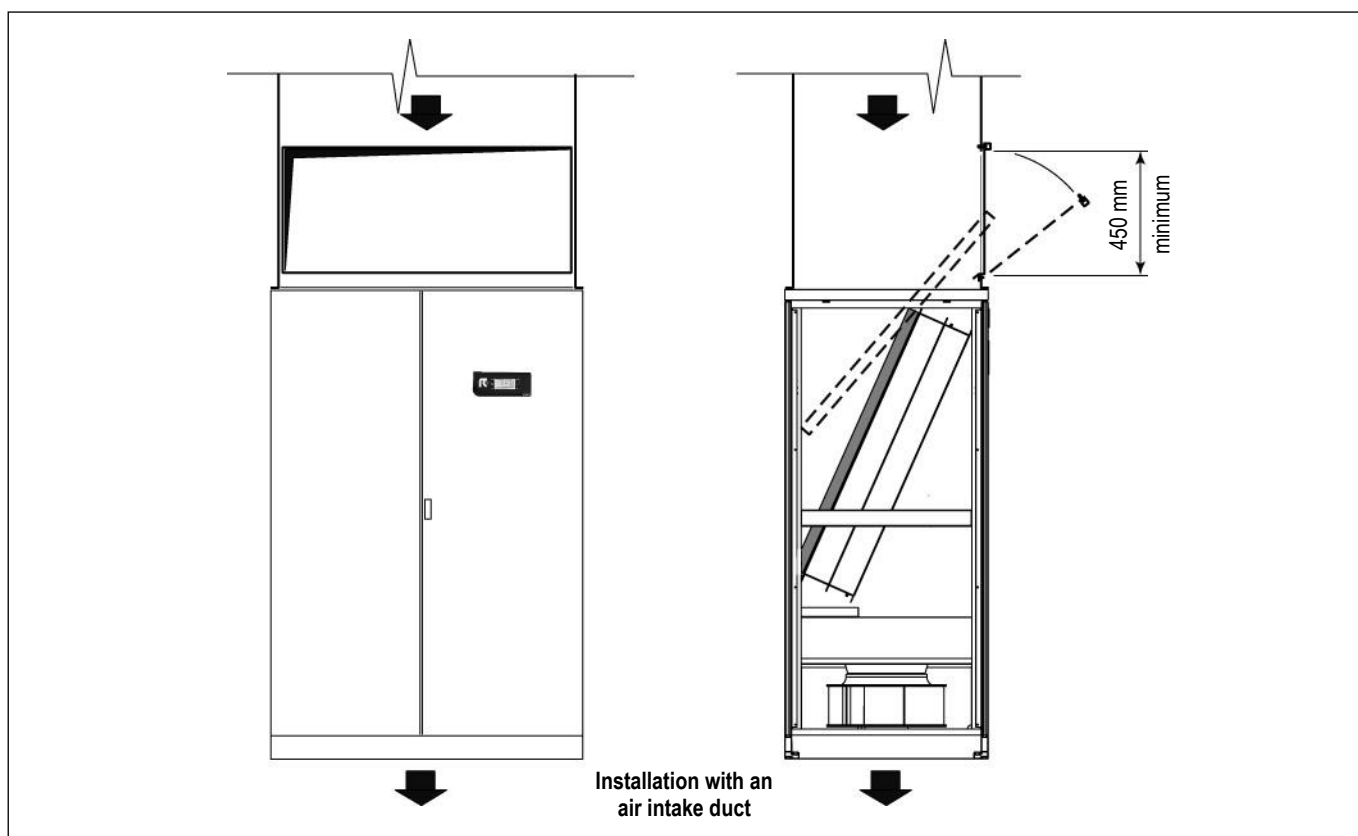
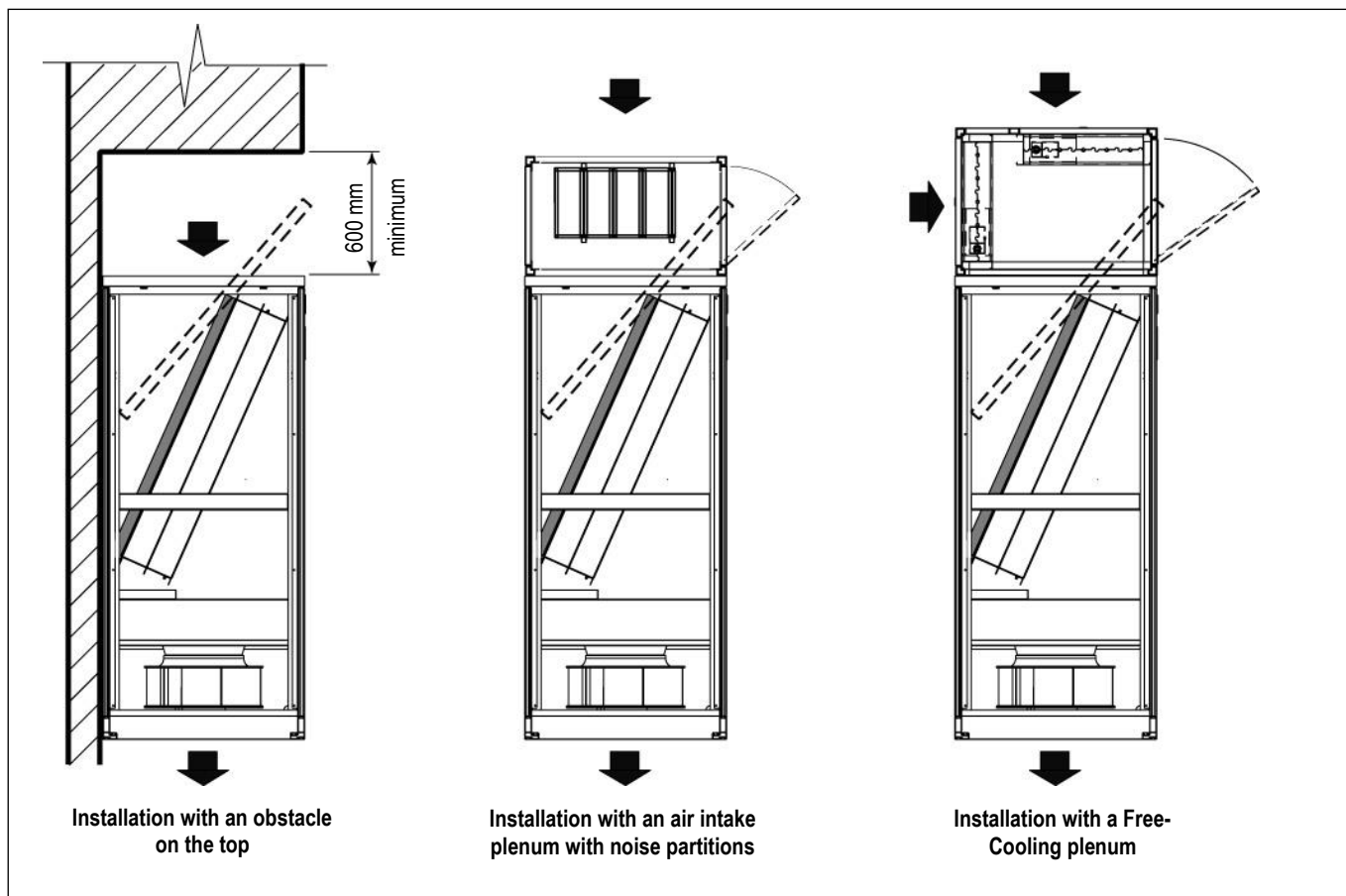





for a greener tomorrow

Eco Changes is the Mitsubishi Electric Group's environmental statement, and expresses the Group's stance on environmental management. Through a wide range of businesses, we are helping contribute to the realization of a sustainable society.



## MITSUBISHI ELECTRIC HYDRONICS & IT COOLING SYSTEMS S.p.A.

Via Roma 5 • 27010 Valle Salimbene (PV) • Italy  
Ph. +39 0382 433811 • Fax +39 0382 587148

[www.rcitcooling.com](http://www.rcitcooling.com)  
[www.melcohit.com](http://www.melcohit.com)